

Power tools for mechanical design.

AutoCAD[®]

Mechanical

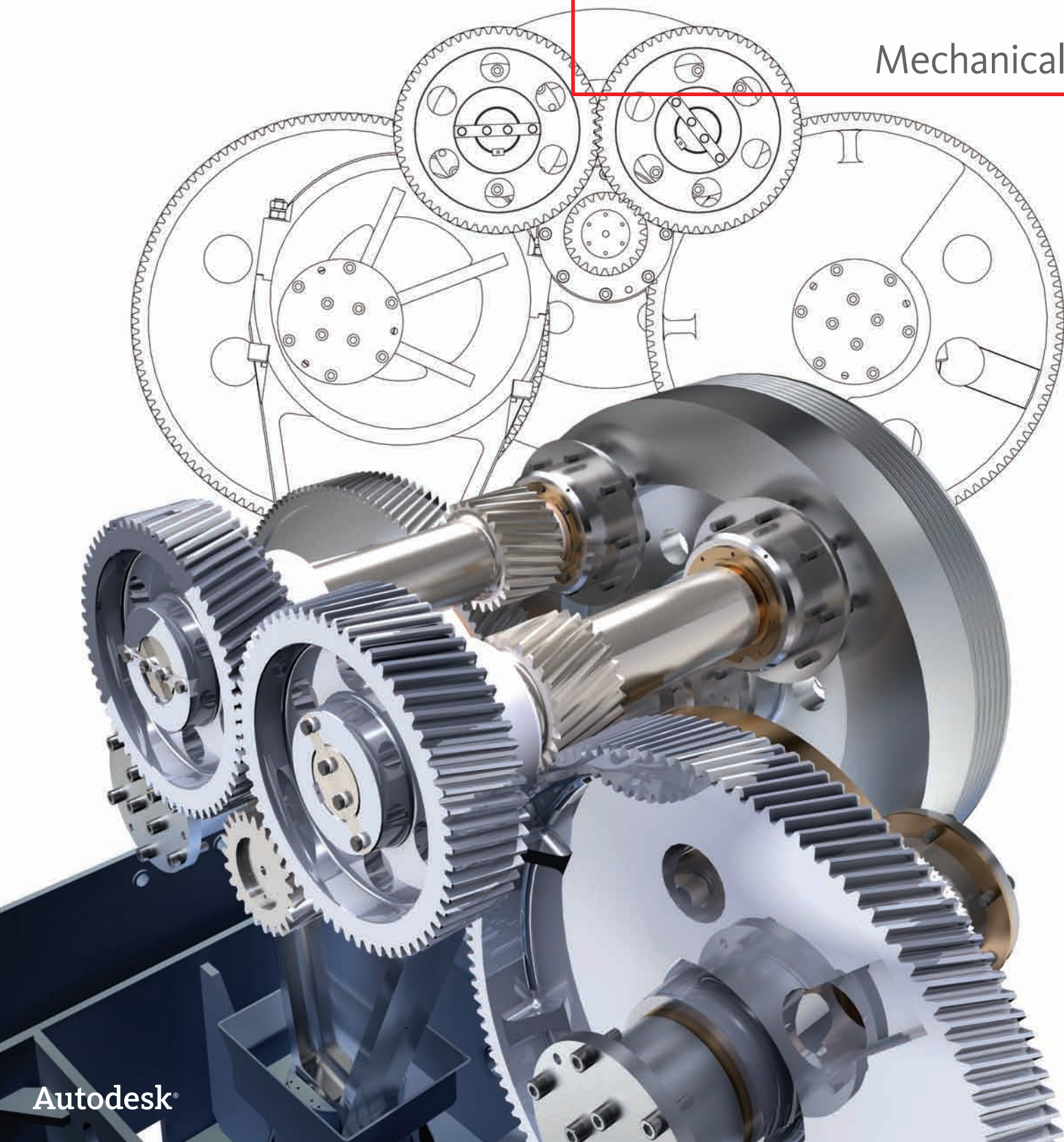

Autodesk[®]

The AutoCAD Mechanical Advantage

To compete and win in today's design marketplace, engineers need to create and revise mechanical drawings faster than ever before. AutoCAD® Mechanical software offers significant productivity gains over standard AutoCAD® software by simplifying complex mechanical design work.

Contents

Design and Drafting Productivity Tools	3
Standards-Based Drafting and Part Libraries	6
Machinery Generators and Calculators	8
Documentation and Reporting Tools.....	10
Collaboration and Data Management	12
Learn More or Purchase	14

With comprehensive libraries of standards-based parts and tools for automating common design tasks, AutoCAD Mechanical accelerates the mechanical design process. Innovative design and drafting tools are wholly focused on ease of use for the AutoCAD user.

Keeping the AutoCAD user experience intact allows designers to maintain their existing workflows while adopting the enhanced functionality of AutoCAD Mechanical at their own pace. Designers gain a competitive edge by saving countless hours of design time and rework, so they can spend time innovating rather than managing workflow issues.

Feature	AutoCAD®	AutoCAD® Mechanical
Full AutoCAD Functionality	•	•
Familiar AutoCAD Interface	•	•
Powerful Drafting Tools	•	•
DWG™ Compatibility	•	•
700,000 Standard Parts and Features		•
Support for International Standards		•
Machinery Generators and Calculators		•
Smart Dimensioning Tools		•
Automatic Hidden Lines		•
Associative Balloons and BOMs		•
Integrated Data Management		•
Autodesk® Inventor® Associativity		•

Design and Drafting Productivity Tools

Built to save users time, AutoCAD Mechanical has a specific tool for almost every aspect of the mechanical design process.

Mechanical Drawing Toolbar

Create drawings more accurately with purpose-built tools. AutoCAD Mechanical provides options beyond those in basic AutoCAD software for drawing creation, including more than 30 options for creating rectangles, arcs, and lines; specialty lines for breakout views and section lines; and mechanical centerlines and hatching additions.

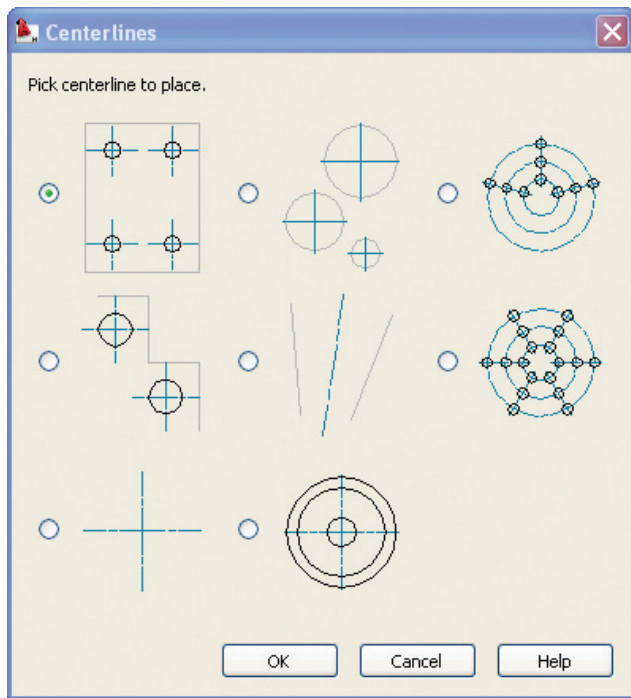

Automatic Hidden Lines

Reduce drafting effort with automatically generated hidden lines that update to reflect drawing revisions. Perform 2D hidden-line calculations based on user-defined foreground and background selections that update automatically. These selections automatically redraw geometry, reducing the tedious manual task of trimming and changing properties of lines in AutoCAD. The 2D Hide feature also warns users of potential geometrical errors and provides a graphical workflow that is easy to learn and use.

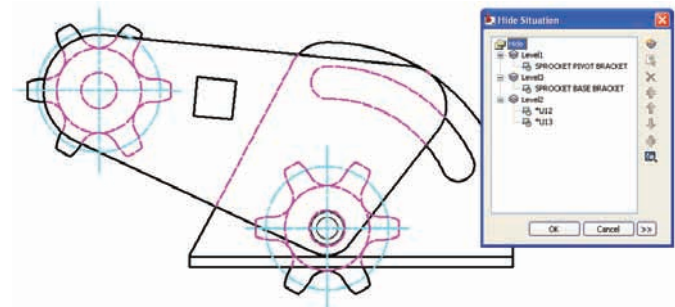

Constraint Manager

Design more intuitively and efficiently by defining parametric constraints instead of manually drafting part geometry. Using the constraint manager, users can easily build intelligence into their designs by incorporating dynamic constraint relationships such as parallel, tangent, and perpendicular. Once the parameters are defined, the constraint manager automatically updates geometry to maintain accurate relationships as the design changes.

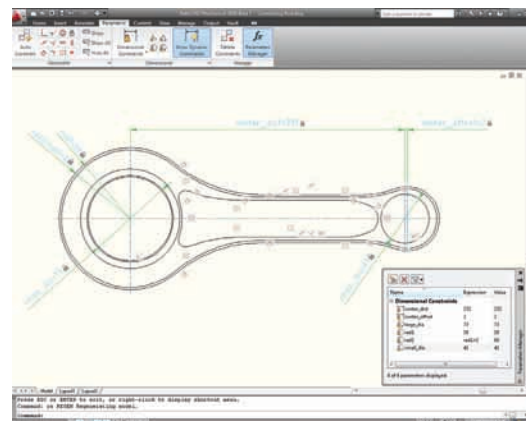

Design and Drafting Productivity Tools

Streamlined Design Environment

AutoCAD Mechanical features a streamlined user interface. Find your favorite tools and commands faster, locate lesser-used tools more efficiently, and discover relevant new features more easily. The result is less time searching through menus and toolbars, and more time getting your work done.

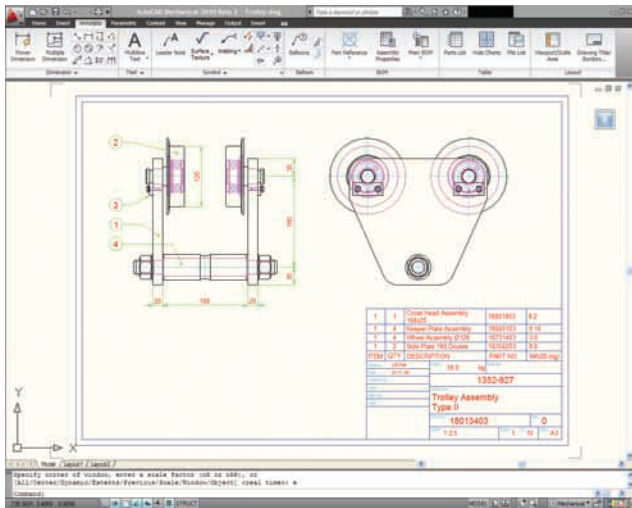

Workspaces

Quickly customize toolbars and settings with the Workspaces toolbar, which offers a pull-down menu where designers can easily store and access different user-interface setups. Several prebuilt workspaces ship with the product, including the classic AutoCAD workspace as well as workspaces that make it easier to learn AutoCAD Mechanical.

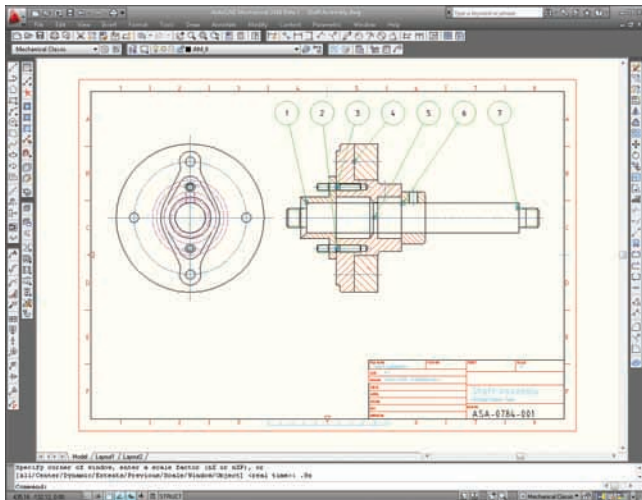

Power Dimensions

Quickly change, edit, or delete dimensions, saving significant time and effort. AutoCAD Mechanical makes AutoCAD dimensions easier to use with abbreviated dialog boxes that conveniently control and expand only the variables relevant for manufacturing. With automatic dimensioning, users can create multiple dimensions with minimal input, resulting in instant groups of ordinate, parallel, or symmetric items that are appropriately spaced. Smart dimensioning tools force overlapping dimensions to automatically space themselves appropriately while integrating tolerance and fit list information into the drawing. Inspection dimensions enable users to specify testing criteria.

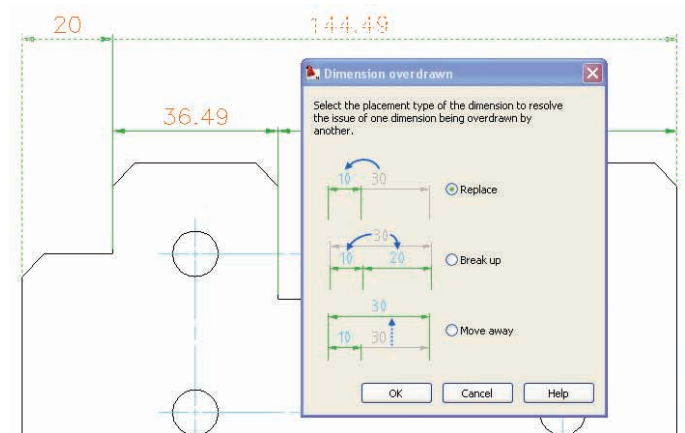

Dimension Stretch

Easily update designs to specific sizes and shapes simply by changing the dimension values. The geometry of a design resizes accordingly. For complex designs, use multiple selection windows to choose exactly which geometry should be changed by the dimension value.

Design and Drafting Productivity Tools

Power Snaps

Ease the repetitive task of geometry selection by using task-based power snap settings. AutoCAD Mechanical includes five settings for object snaps, as well as many more options for selecting specific geometry than basic AutoCAD software offers. Quickly choose the snap setting that works best for the task at hand.

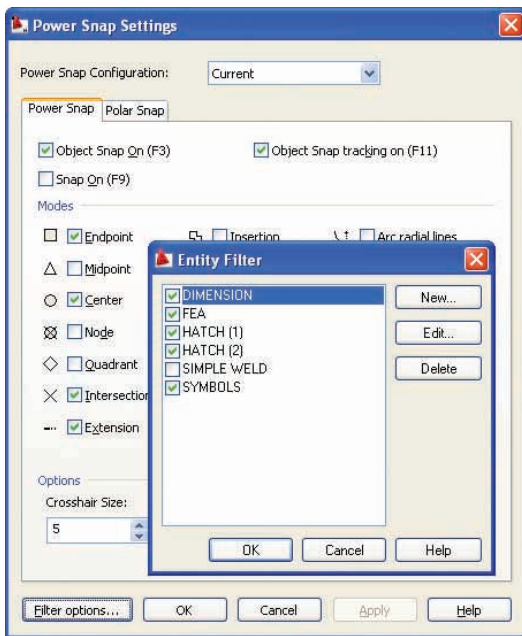

Associative Detailing Tools

Update drawings quickly with powerful tools that enable users to edit previous operations, saving valuable design time. Easily re-edit features without having to remove and re-create the original feature. For example, resize a chamfer using the original dialog parameters by simply double-clicking the chamfer.

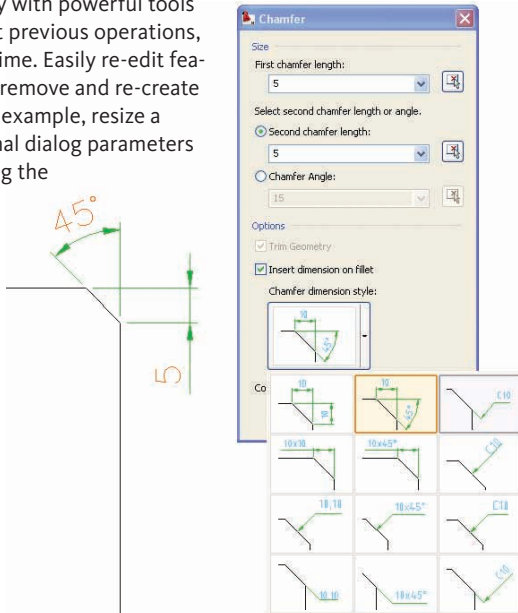

Design Navigation

Use the design navigation feature to better understand how designs fit together. As the user moves the cursor across a design, a small window displays part names. Expand this window to show parent/child relationships inside assemblies. The entire part geometry is highlighted, with a single grip placed at the base point and an arrow showing default orientation.

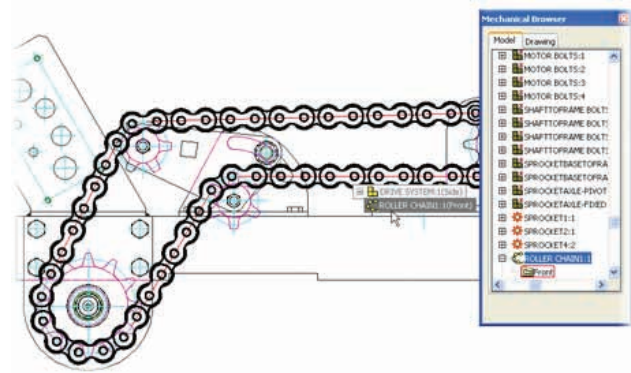

Software Developer Kit (SDK)

Customize and combine features in AutoCAD Mechanical to achieve higher levels of productivity. The SDK for the API (application programming interface) provides information to customize and automate individual features or combinations of features in AutoCAD Mechanical. It includes updated API documentation and sample scripts.

Standards-Based Drafting and Part Libraries

Realize consistent results on the shop floor by producing accurate designs using a comprehensive set of more than 700,000 standard parts.

Standard Parts, Features, and Holes

Produce accurate designs faster with standards-based parts from the libraries in AutoCAD Mechanical, saving hours of design time. AutoCAD Mechanical contains more than 700,000 parts such as screws, nuts, washers, pins, rivets, and bushings. It also includes 100,000 predrawn features such as undercuts, keyways, and thread ends. AutoCAD Mechanical also contains more than 8,000 predrawn holes, including through, blind, and oblong holes. When users incorporate these features into a design, AutoCAD Mechanical automatically cleans up the insertion area, reducing the need for manual edits.

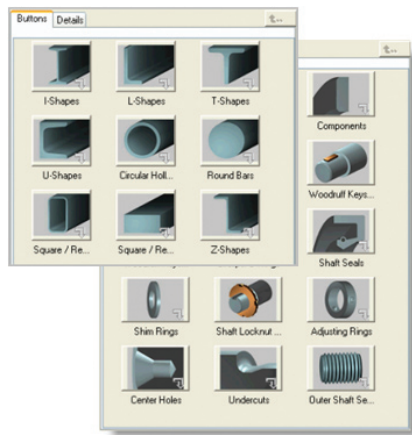

Standards-Based Design

Multiply productivity with tools that help users deliver consistent, standards-based design documentation. AutoCAD Mechanical supports ANSI, BSI, CSN, DIN, GB, ISO, and JIS drafting environments. Using standards-based drafting environments helps groups of users maintain a common form of communication.

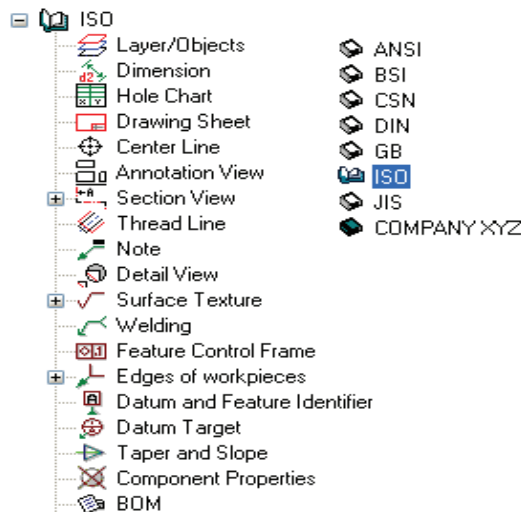

Standard Part Favorites

Customize AutoCAD Mechanical to fit your workflow. Users can now save frequently used parts as favorites, where they can be accessed quickly for easy reuse.

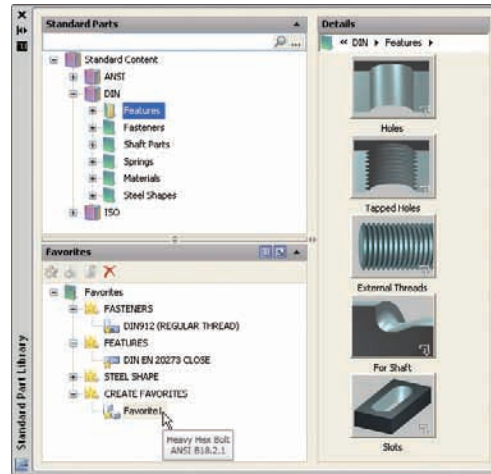

Part Publishing

Save time and maintain consistency across projects by enabling users to easily leverage their existing part designs. Part publishing offers the capability to add new part families to the library.

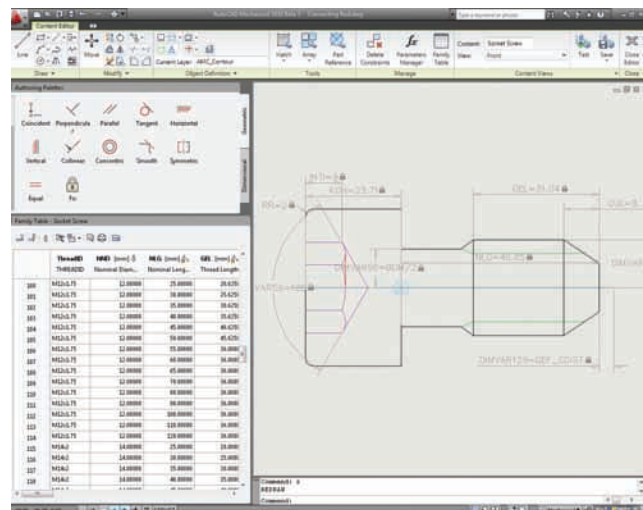

Standards-Based Drafting and Part Libraries

Screw Connections

Automate the creation and management of screw connections with this easy-to-use graphical interface that supplies thousands of connection options, while helping users choose the best parts for their design. Create, copy, and edit entire fastener assemblies at one time. Pick the desired type of screw, corresponding washers, and type of nut. Appropriate sizes for nuts, washers, and holes are presented depending on the screw selected and material thickness. The hole is added to the part where specified, and the entire fastener assembly is inserted into the hole. All inserted parts are instantly captured by the bill of materials (BOM).

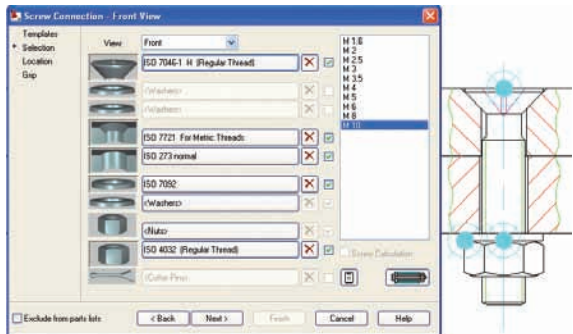

2D Structural Steel Shapes

Create designs more quickly and accurately using predrawn geometry. AutoCAD Mechanical contains more than 11,000 predrawn standard structural steel shapes that users can incorporate quickly into any design. These include common structural shapes such as U-shape, I-shape, T-shape, L-shape, Z-shape, rectangular tube, round tube, rectangular full beam, and rectangular round beam.

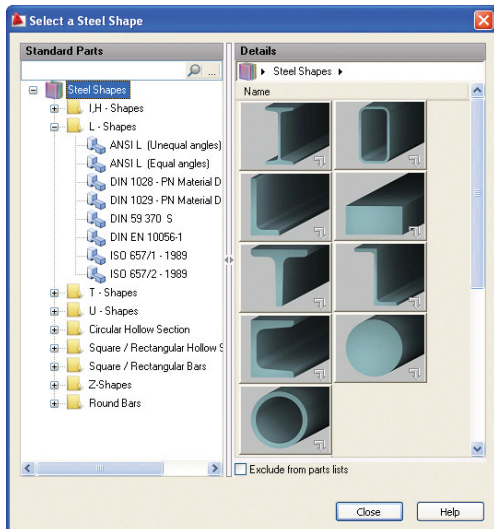

Annotation Symbols and Notes

Save time and increase accuracy by using standards-based mechanical symbols and notes. AutoCAD Mechanical includes drafting tools to create standards-based surface texture symbols, geometric dimensioning and tolerances, datum identifiers and targets, notes, taper and slope symbols, and weld symbols.

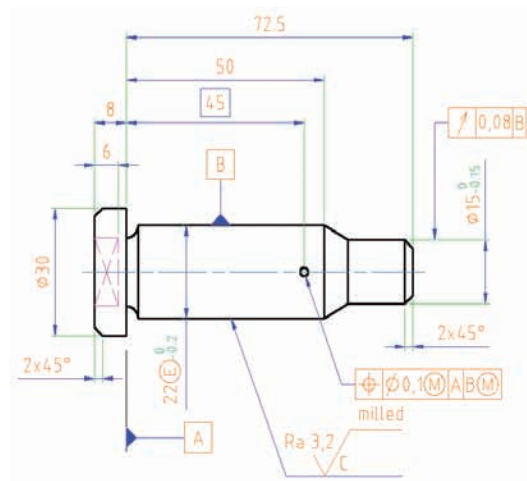

Title and Revision Blocks

Quickly generate drawings with uniform, precreated title and revision blocks. AutoCAD Mechanical includes a full set of configurable title and revision blocks in both English and metric units. Users can easily customize these blocks with company-specific information.

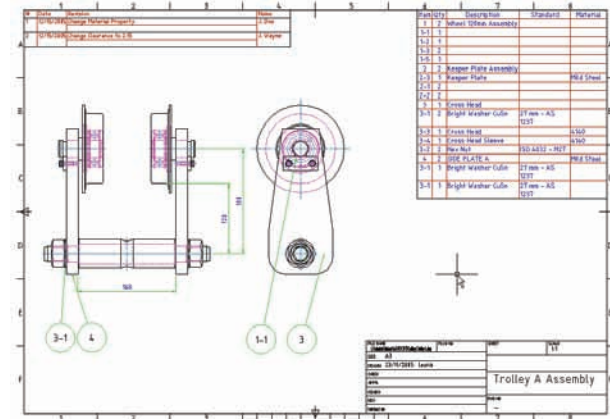

Machinery Generators and Calculators

Accelerate the design process and improve design accuracy with a comprehensive collection of automated machinery generators and calculators.

Spring Generator

Select, calculate, and insert compression springs, extension springs, torsion springs, and Belleville spring washers into a design using the spring generator, a fast, valuable, and easy-to-use tool. Control the representation type of the spring, and create a specification form to incorporate in the drawing. The spring calculator helps users select the right spring on the first try.

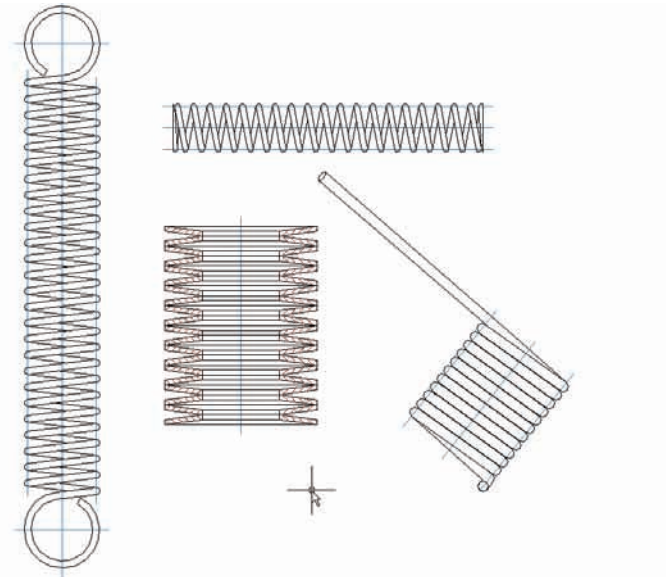

Shaft Generator

Accelerate shaft drawings and analysis with minimal input and effort. The extensive library of common features and parts makes it easy to finish the drawing. The shaft generator creates drawing views of solid and hollow shafts. Add standard features such as center holes, chamfers, cones, fillets, grooves, profiles, threads, undercuts, and wrench fittings. In addition, standard parts commonly found in shafts, such as bearings, gears, retaining rings, and seals, are supported and conveniently grouped together. Automatically create associated side views and validate the capability of completed shafts with built-in calculated graphs and tables.

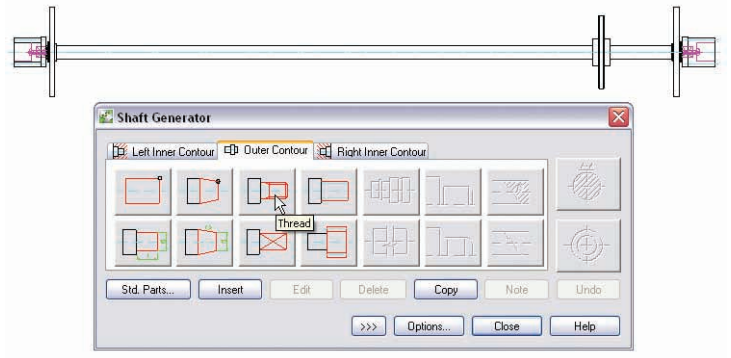

Belt and Chain Generator

Quickly and easily create chain and belt assemblies that are based on engineering calculations for optimum performance. Automatically calculate optimal lengths for chains and belts based on user input, and insert these assemblies into a design. Simply select belts and chains from the standard libraries to get started.

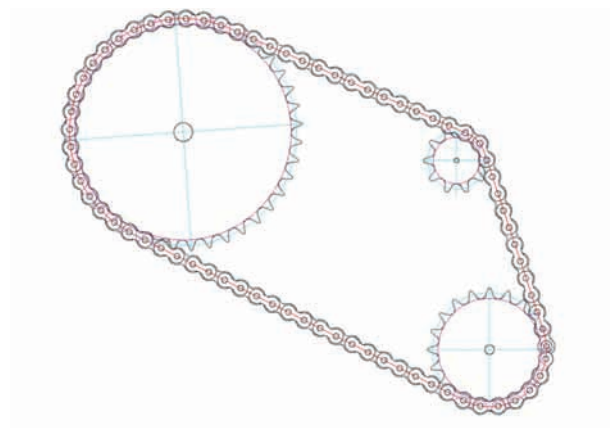

Machinery Generators and Calculators

Cam Generator

Quickly design and analyze cams while increasing access to crucial information about the cam's functionality. The cam generator creates linear, circular, and cylindrical cams based on the input border connections set by the user. Calculate and display acceleration and jerk, as well as the cam curve path. Couple driven elements to the cam, and create computer numerical control (CNC) data via the curve path.

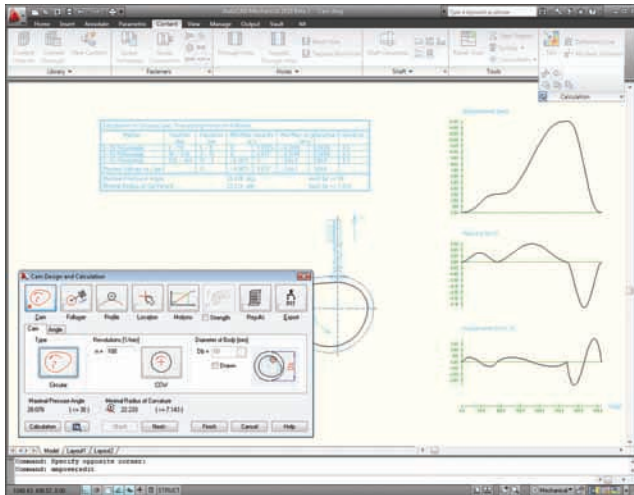

Moment of Inertia, Deflection, and Load Calculations

Save time and reduce the tedium of manual calculations by using built-in engineering calculators. Instantly generate many different sets of calculated graphs and tables for screws, bearings, cams, and shafts with minimal additional input. Quickly perform engineering calculations, such as a moment of inertia of a cross section or deflection of a profile with given forces and supports.

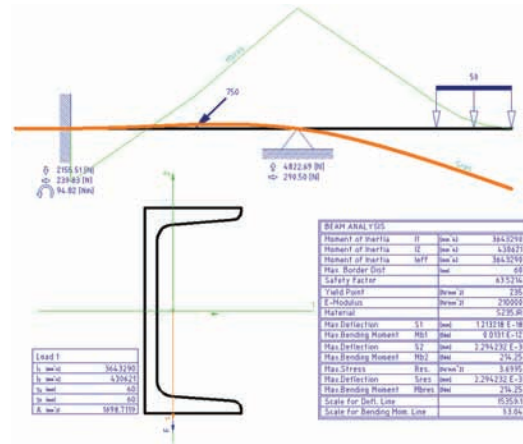

2D Finite Element Analysis (FEA)

Quickly identify potential areas of failure and analyze a design's integrity under various loads, thereby avoiding costly product testing or field maintenance. The 2D FEA feature is an easy-to-use tool for determining the resistance capability of an object under static load. Add movable and fixed supports to the part to be analyzed, as well as stress points, lines, and areas.

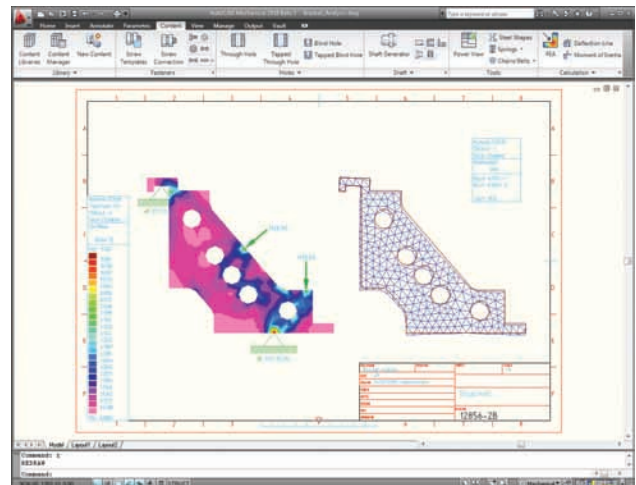

Documentation and Reporting Tools

AutoCAD Mechanical helps workgroups organize and manage valuable design data and provide accurate reports to downstream users.

Balloons and Bills of Materials

Use standards-based balloons and parts lists and automatically update the BOM to seamlessly track any changes—helping to keep teams on schedule by reducing costly breaks in production due to incorrect part counts, identification, and ordering. AutoCAD Mechanical includes support for multiple parts lists per drawing, collapsible assemblies, automatic recognition of standard parts, and customizable options so features can be revised to match current company practices. The new BOM configuration manager simplifies setup and customization.

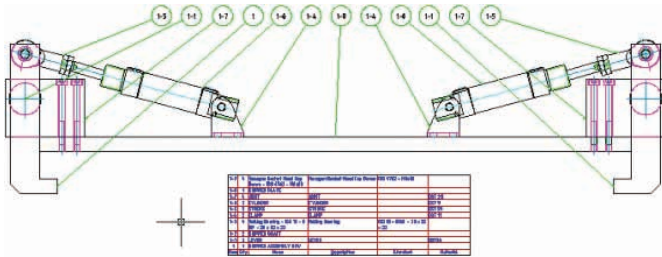

Automatic BOM Extraction

Save time and maintain accurate information when extracting BOM data from legacy DWG™ files. Easily reuse data and generate accurate BOM reports from legacy DWG files created with earlier versions of AutoCAD or third party applications. Automatic extraction of both parts lists and title block information frees users from the error-prone process of manually opening and tracking sub-assemblies.

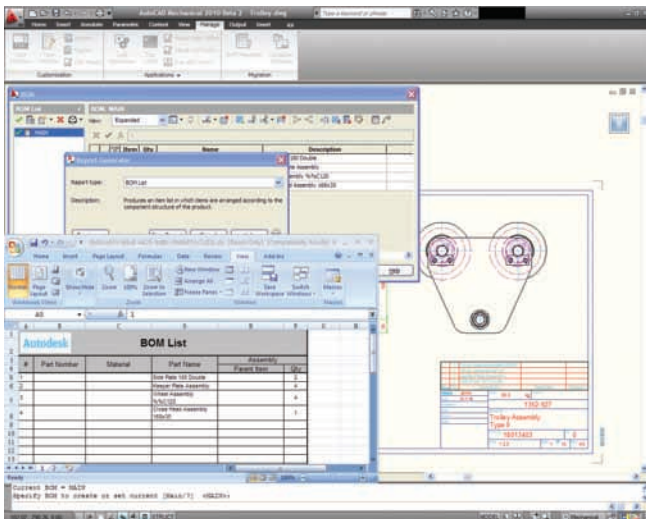

Hole Charts

Quickly create accurate hole charts that automatically update based on design changes, reducing errors associated with creating charts manually. When users place standard holes in the design, the software automatically generates hole charts that display detailed design information. Dynamic highlighting helps ensure that all holes needed for the chart are accurately represented. After the user places a chart, it remains linked to the design, dynamically updating to reflect changes and additions. Filtering capabilities enable users to separate different hole sizes into different hole charts for streamlined manufacturing processes.

List of Coordinates for Counterbored Holes						
Hole	X	Y	Ø	Description	Standard	
1.1	21	35	Ø6.5	Counterbore	DN 976 T1-R1 - S	
1.2	35	21	Ø6.5	Counterbore	DN 976 T1-R1 - S	
1.3	35	51	Ø6.5	Counterbore	DN 976 T1-R1 - S	
1.4	51	35	Ø6.5	Counterbore	DN 976 T1-R1 - S	

List of Coordinates for Tapped Holes						
Hole	X	Y	Ø	Description	Standard	
2.1	18	18	Ø8.38	Metric ISO-Thread ISO 261 - M18		
2.2	18	48	Ø8.38	Metric ISO-Thread ISO 261 - M18		
2.3	48	18	Ø8.38	Metric ISO-Thread ISO 261 - M18		
2.4	48	48	Ø8.38	Metric ISO-Thread ISO 261 - M18		

List of Coordinates for Blind Holes						
Hole	X	Y	Ø	Description	Standard	
3.1	18	35	Ø4	Blind Hole	Acc. to ISO 273 - 4 x 21	
3.2	34.99	18	Ø4	Blind Hole	Acc. to ISO 273 - 4 x 21	
3.3	35	48	Ø4	Blind Hole	Acc. to ISO 273 - 4 x 21	
3.4	48	35	Ø4	Blind Hole	Acc. to ISO 273 - 4 x 21	

Automatic Layer Management

Avoid errors and save time by easily organizing and maintaining drawing layers. The intelligent layer management system in AutoCAD Mechanical automatically places items on the correct layer, color, and linetype as you create your drawing. Users can easily customize the system to meet specific company requirements.

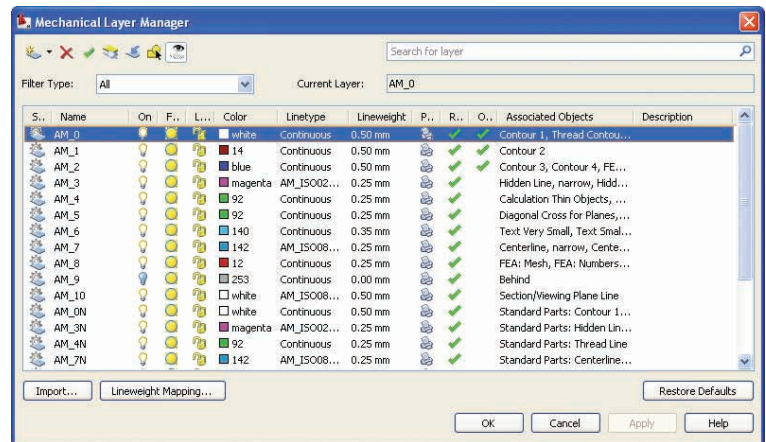

Collaboration and Data Management

The intelligent file formats in AutoCAD Mechanical and tight integration with Autodesk® manufacturing products facilitate collaboration by enabling workgroups to share accurate design information reliably and securely.

Autodesk® Inventor® Associativity

Easily detail and document native Autodesk® Inventor® part and assembly models. Browse through Inventor files, and begin creating new, linked AutoCAD Mechanical drawings that are based on the most current 3D designs. Incorporate design revisions quickly and easily through the associative link, which alerts users to changes and regenerates the 2D drawing. Visualize design intent by shading and rotating solid models, and review other attributes associated with the Inventor design. Information stored in Inventor models is automatically available to the BOM database in AutoCAD Mechanical, so users can quickly add balloons, parts lists, and annotations.

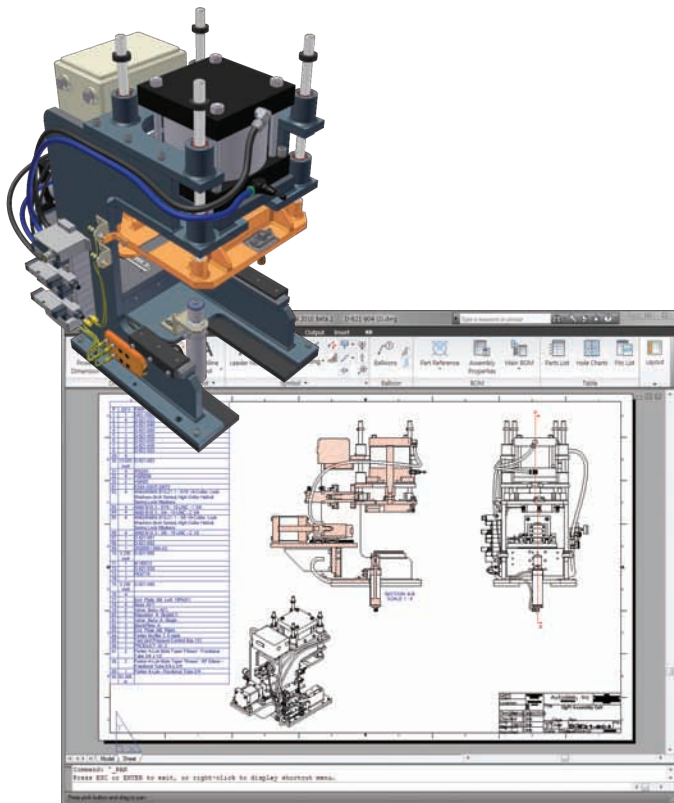

STEP/IGES Translators

Simplify accurate collaboration with suppliers and customers by enabling sharing and reuse of design data with other CAD/CAM systems. Read and write design and drawing data using industry-standard formats.

Autodesk® DWF™

Publish DWF™ files directly from Autodesk manufacturing design applications and securely collaborate on 2D and 3D designs with customers, suppliers, planners, and others outside your engineering workgroup. Using the free* Autodesk® Design Review software, team members can digitally review, measure, mark up, and comment on your 2D and 3D designs while protecting your intellectual property. Tight integration with Autodesk manufacturing products allows for accurate communication of design information, including assembly instructions, bills of materials (BOM), and finite element analysis (FEA) results, without requiring CAD expertise. Autodesk Design Review tracks comments and their status, and the DWF-based markups can be “round-tripped,” speeding the revision process and minimizing information loss.

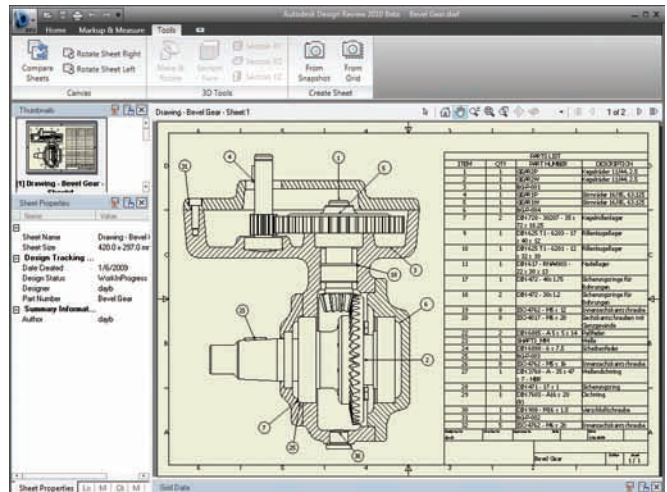

Collaboration and Data Management

Integrated Data Management

Securely store and manage work-in-progress design data and related documents with data management tools for workgroups. Team members can accelerate development cycles and increase their company's return on investment in design data by driving design reuse.

Autodesk® Vault Manufacturing

Autodesk® Vault Manufacturing software (sold separately and previously known as Autodesk® Productstream®) securely stores and manages engineering information, design data, and documents, enabling you to shorten the design-to-manufacturing process. It helps design, engineering, and manufacturing departments across separate locations collaborate and share Digital Prototyping information. It also gives your design departments advanced tools to track engineering change orders, manage BOMs, and promote earlier collaboration through integration with manufacturing business systems. With support for multi-CAD environments, Vault allows you to share and manage designs and engineering data created with third-party software and AutoCAD® software throughout the product lifecycle.

Language Translation

Accelerate language translation and simplify international communications with built-in tools. AutoCAD Mechanical offers a basic library of prewritten language strings that can automatically translate drawing text from one language to another. The library is an open format that can be expanded and modified.

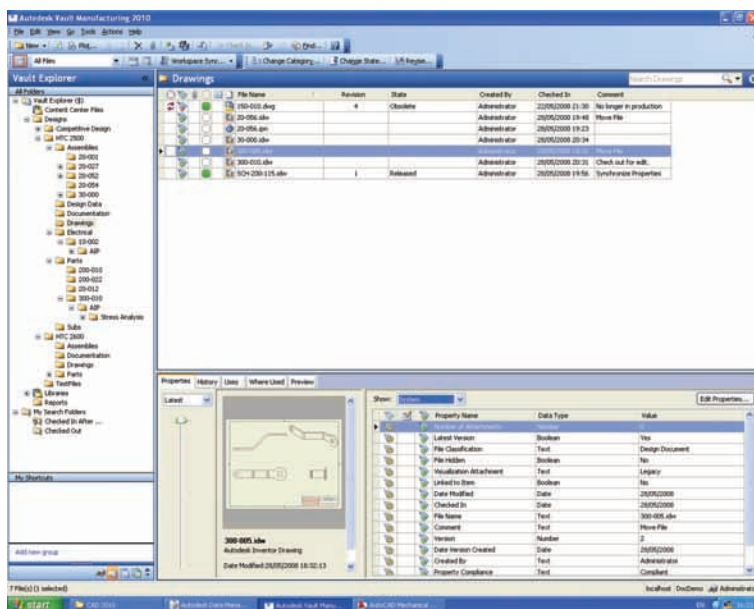
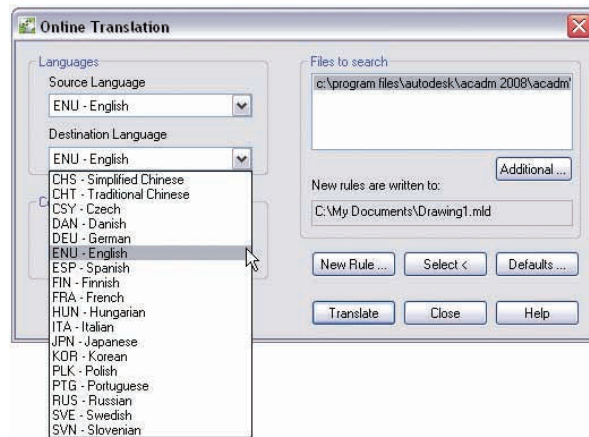

Digital Prototyping for the Manufacturing Market

Autodesk is a world-leading supplier of engineering software, providing companies with tools to help them experience their ideas before they are real. By putting powerful Digital Prototyping technology within the reach of mainstream manufacturers, Autodesk is changing the way manufacturers think about their design processes and is helping them create more productive workflows. The Autodesk approach to Digital Prototyping is unique in that it is scalable, attainable, and cost-effective, which allows a broader group of manufacturers to realize the benefits with minimal disruption to existing workflows, and provides the most straightforward path to creating and maintaining a single digital model in a multidisciplinary engineering environment.

Learn More or Purchase

Access specialists worldwide who can provide product expertise, a deep understanding of your industry, and value that extends beyond your software purchase. To purchase AutoCAD Mechanical, contact an Autodesk Premier Solutions Provider or Autodesk Authorized Reseller. Locate a reseller near you at [visit **www.autodesk.com/reseller**](http://www.autodesk.com/reseller).

Autodesk Learning and Education

From instructor-led or self-paced classes to online training or education resources, Autodesk offers learning solutions to fit your needs. Get expert guidance at an Autodesk Authorized Training Center (ATC[®]) site, access learning tools online or at your local bookstore, and validate your experience with Autodesk certifications. Learn more at [**www.autodesk.com/learning**](http://www.autodesk.com/learning).

Autodesk Services and Support

Accelerate return on investment and optimize productivity with innovative purchase methods, companion products, consulting services, and support from Autodesk and Autodesk authorized partners. Designed to get you up to speed and keep you ahead of the competition, these tools help you make the most of your software purchase—no matter what industry you are in. Learn more at [**www.autodesk.com/servicesandsupport**](http://www.autodesk.com/servicesandsupport).

Autodesk Subscription

Get the benefits of increased productivity, predictable budgeting, and simplified license management with Autodesk[®] Subscription. You get any new upgrades of your Autodesk software and any incremental product enhancements, if these are released during your Subscription term. In addition, you get exclusive license terms available only to Subscription members. A range of community resources, including web support direct from Autodesk technical experts, self-paced training, and e-Learning, help extend your skills and make Autodesk Subscription the best way to optimize your investment. Learn more at [**www.autodesk.com/subscription**](http://www.autodesk.com/subscription).

*Free products are subject to the terms and conditions of the end-user license agreement that accompanies download of the software.

Cover image courtesy of Prensa Jundiá, Brazil

Autodesk, AutoCAD, Autodesk Inventor, DWF, DWG, Inventor, and Productstream are registered trademarks or trademarks of Autodesk, Inc., and/or its subsidiaries and/or affiliates in the USA and/or other countries. All other brand names, product names, or trademarks belong to their respective holders. Autodesk reserves the right to alter product offerings and specifications at any time without notice, and is not responsible for typographical or graphical errors that may appear in this document.
© 2009 Autodesk, Inc. All rights reserved. 00000000000118302