

Get wired.

AutoCAD®

Electrical

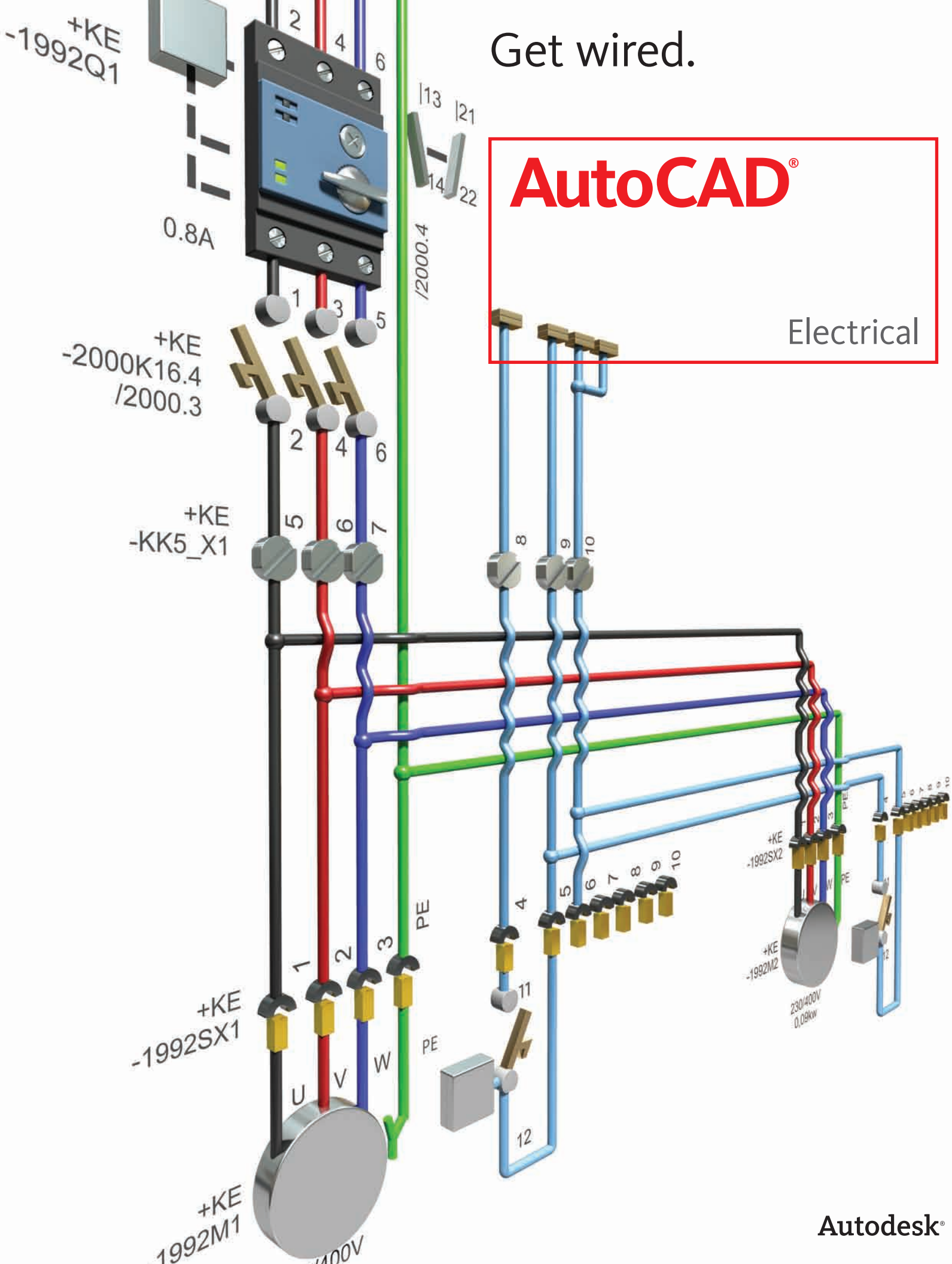

The AutoCAD Electrical Advantage

To succeed in today's global marketplace, electrical controls designers can no longer afford to rely on generic software applications to get the job done. AutoCAD Electrical offers control engineers a competitive edge by helping save hours of effort, so they can spend more time innovating.

Contents

Error Checking and Prevention	3
Standards-Based Drafting and Component Libraries.....	4
Design and Drafting	
Productivity Tools	5
Schematic Design Tools	8
Panel Layout Tools	10
Programmable Logic Controller Tools.....	11
Comprehensive Terminal Management.....	12
Collaboration and Interoperability	13
Data Management and Reporting Tools	14
Data Migration Tools.....	15
Learn More or Purchase	16

AutoCAD® Electrical is AutoCAD® software for controls designers, purpose-built to create and modify electrical control systems. It contains all the functionality of AutoCAD, the world's leading CAD software, plus a comprehensive set of electrical-specific features and functions that offer significant productivity gains.

AutoCAD Electrical helps you stay ahead of the competition by automating control engineering tasks, such as building circuits, numbering wires, and creating bills of material. AutoCAD Electrical provides a library of more than 650,000 electrical symbols and components, includes real-time error checking, and enables electrical and mechanical teams to collaborate on digital prototypes built with Autodesk® Inventor® software. As part of the Autodesk solution for Digital Prototyping, AutoCAD Electrical helps manufacturers get their products to market faster with lower costs.

Feature	AutoCAD®	AutoCAD® Electrical
Full AutoCAD Functionality	●	●
Familiar AutoCAD Interface	●	●
Powerful Drafting Tools	●	●
DWG™ Compatibility	●	●
Comprehensive Symbol Libraries		●
Electrical-Specific Drafting Features		●
Real-time Error Checking		●
Schematic Design Tools		●
Panel Layout Tools		●
Terminal Management Tools		●
PLC I/O Tools		●
Automatic BOM Generation		●
Autodesk® Inventor® Associativity		●

Error Checking and Prevention

AutoCAD® Electrical software includes automatic error-checking capabilities that help designers perform real-time diagnostics to catch problems before the build phase of a project.

Automatic Wire Numbering and Component Tagging

Spending long hours manually assigning wire numbers and component tags is a thing of the past, as are the potential errors inherent in that process. AutoCAD Electrical drafting software automatically places sequential or reference-based numbers on all wires and components, based on the configuration you choose. Reference-based numbers and tags automatically get a suffix when necessary so that names are unique and the software can renumber the entities as the design requirements change. This numbering convention is flexible enough to meet nearly any design requirement.

In addition, if AutoCAD Electrical determines that an inserted wire number will “bump into” something, it automatically searches laterally along the wire for a clear spot to place the wire number. If that fails, it searches for a clear spot away from the wire. When it finds one, it places the number and automatically draws a leader back to the wire.

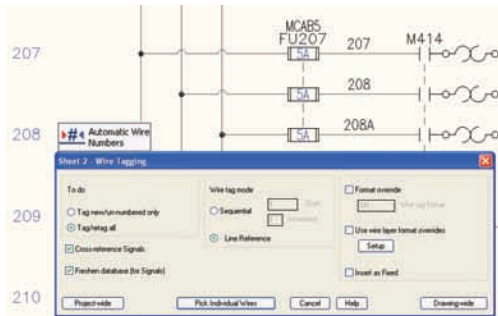

Real-Time Error Checking

Avoid costly errors at build time by catching and removing errors during design. AutoCAD Electrical drafting software constantly compares the requested changes with the current project and alerts you to potential errors such as duplicated wire numbers or component tags as they occur.

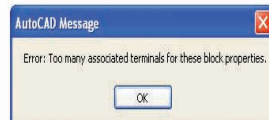

Real-Time Coil and Contact Cross-Referencing

Significantly reduce the risk of costly mistakes associated with assigning too many contacts to a relay. AutoCAD Electrical sets up a parent/child relationship between the two and keeps track of how many contacts are assigned to any given coil or multi-contact device. When you exceed the limit, you get an alert.

Another benefit of this feature is the ability to assign the next available set of terminal pin numbers to each inserted “child” contact, based on the pin list properties of the parent coil. Display cross-referencing information in almost any format on the drawings, and run cross-referencing reports at any time.

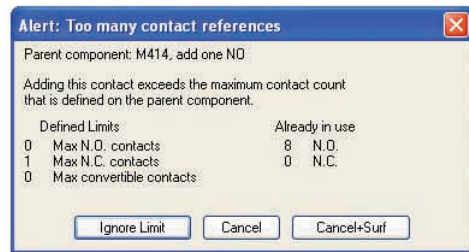

Electrical Audit Report

Missing or incorrect wire numbers can cause major headaches. Use the audit report function to analyze and report such design anomalies so you can correct them before they reach manufacturing.

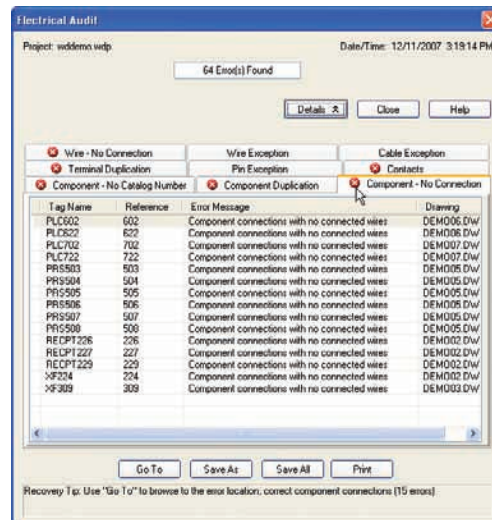

Standards-Based Drafting and Component Libraries

AutoCAD Electrical supports international standards and provides comprehensive libraries of manufacturer content and symbols, enabling users to easily create standards-based designs that comply with industry requirements.

Extensive Manufacturers' Catalog Content

Use real manufacturers' catalog data to streamline the design process. AutoCAD Electrical comes with a manufacturers' catalog database that contains more than 650,000 components and symbols from the industry's most popular vendors. These components provide a full spectrum of input and output (I/O) devices, including switches, sensors, lights, and numerous panel devices, such as wireway and panel enclosures.

Electrical Component Libraries

Easily select commonly used devices to quickly create electrical control systems designs. AutoCAD Electrical provides a simple menu-driven system for inserting electrical devices. Each menu provides access to a comprehensive symbol library that includes push buttons, selector switches, pilot lights, relays, contacts, fuses, terminals, and more.



Support for Multiple Design Standards

Meet your customers' design requirements with support for the JIC, IEC, JIS, and GB international standards. Select symbol libraries, cross-reference settings, wire and device tagging conventions, and much more to meet geographic design requirements.

User-Defined Attributes

Add custom attributes to AutoCAD Electrical symbols and have their contents available in any project reports. Easily communicate company-specific design data by using newly defined metadata to extract information for standard reports.

Symbol Builder

Guide and manage the creation and conversion of AutoCAD® blocks into intelligent AutoCAD Electrical symbols. Built on top of the AutoCAD Block Editor, the Symbol Builder helps create electrical symbols and black boxes that conform to the AutoCAD Electrical architecture.

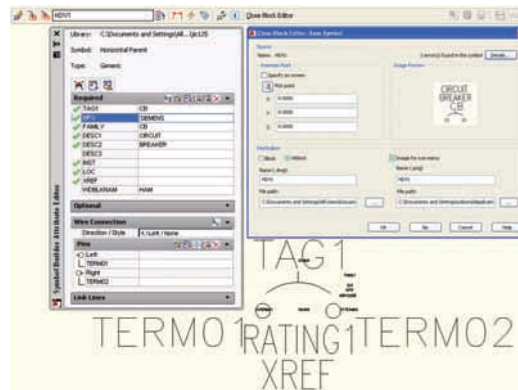

Multidiscipline Symbol Libraries

Quickly generate accurate pneumatic, hydraulic, and piping and instrumentation diagram (P&ID) schematics. The comprehensive symbol libraries include devices such as valves, operators, manifolds, meters, regulators, filters, and more.

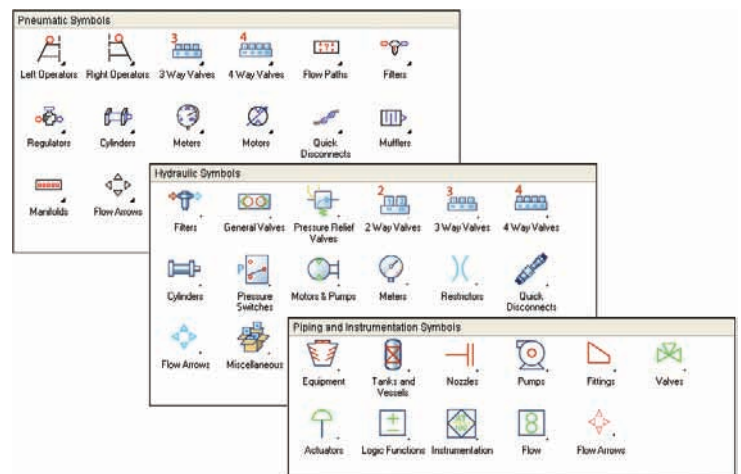

Design and Drafting Productivity Tools

AutoCAD Electrical software offers controls designers immediate productivity gains with a complete set of specialized features and tools developed specifically for the creation of accurate, industry-standard electrical control systems.

Streamlined Design Environment

AutoCAD Electrical features a streamlined user interface. Find your favorite tools and commands faster, locate lesser-used tools more efficiently, and discover relevant new features more easily. The result is less time searching through menus and toolbars, and more time getting your work done.

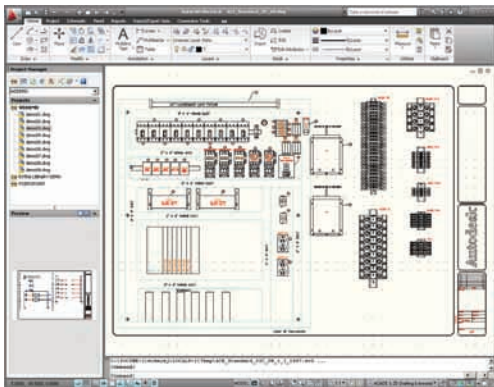

Circuit Builder

Reduce design time and increase drafting efficiency by automating the creation of controls circuits. Dynamically generate rules-based controls circuits based on defining functional requirements, such as components, wiring, ratings, and catalog data.

The Circuit Builder tool gives you the necessary information to help you make sound engineering decisions that are also environmentally “green.” For example, the conductor size that meets the minimum code requirements may be the least expensive to purchase, but it may not provide the best long-term energy and cost savings.

Circuit Builder provides dynamic display of worst-case energy loss costs for a range of conductor sizes against various installation and ambient factors. Suggested wire conductor sizing can be automatically calculated based upon an electrical code requirement.

Size	Count	AWG	Area	Volume	Weight	Resistance	Inductance	Capacitance	Cost
200MCMAL	2	4-0	804	80.00	5.07	273	5.20		\$3702.76
150MCMAL	2	1-1/2	760	80.07	5.07	244	4.72		\$3510.84
100MCMAL	2	1-1/8	640	80.20	4.79	227	4.41		\$3260.84
75MCMAL	2	1-1/4	520	78.82	4.5	218	4.19		\$2980.24
50MCMAL	2	4-8	376	80.17	4.5	218	4.19		\$2680.24
35MCMAL	2	1-1/2	360	76.80	4.36	211	4.09		\$2680.24
30MCMAL	2	4-6	300	80.07	4.36	211	4.09		\$2680.24
25MCMAL	2	1-1/2	260	72.72	4.22	206	4.02		\$2500.76
20MCMAL	2	4-6	204	82.76	4.22	206	4.02		\$2500.76
15MCMAL	2	1-1/8	140	89.47	4.17	2	3.89		\$2727.89

Make better design decisions based on de-rating factors such as wire material type, insulation temperature rating, ambient temperature, run length, power conductor bundling and maximum allowable voltage drop. Circuit Builder can also suggest fuse, breaker, and disconnect ratings based upon motor or power feed load.

Reuse Circuits

Slash design time by reusing common circuits. AutoCAD Electrical gives users the ability to build commonly used circuits once and then save them for reuse in future designs. When you place a saved circuit into a new design, AutoCAD Electrical automatically rennumbers the wires and devices in the circuit to match the configuration of the current drawing or project.

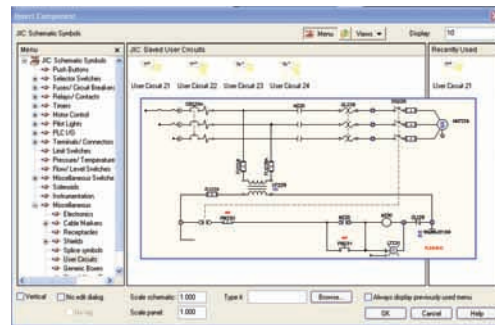

One-Line Diagrams for Motor Control

Quickly create and edit one-line circuit representations that can then help drive accurate annotation of three-line schematic circuit equivalents.

Building on the popular Circuit Builder tool for three-phase motor control, AutoCAD Electrical now enables you to interactively create one-line motor circuit and power feed representations. One-line circuit representations can help drive three-line schematic circuit generation and vice versa.



Design and Drafting Productivity Tools

Multiple Drawing Interface Aware

Simultaneously view and edit multiple drawings at once. AutoCAD Electrical fully supports the multiple document interface (MDI) standard, allowing you to have multiple drawings open at one time. Now you can cut and paste design information between two open drawings without having to close one of them.

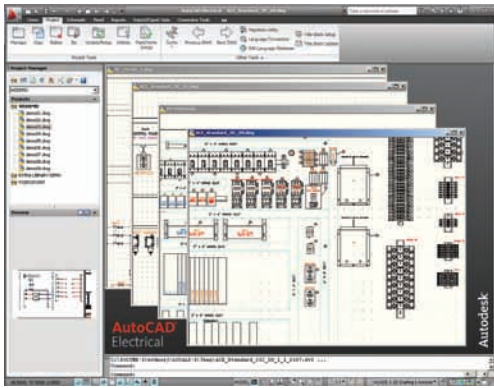

Multiple Wire Insert

By enabling designers to insert multiple wires with a single command, AutoCAD Electrical automates the process of connecting devices with several connection points. And, faster design helps ensure that your projects stay within budget—and on time.

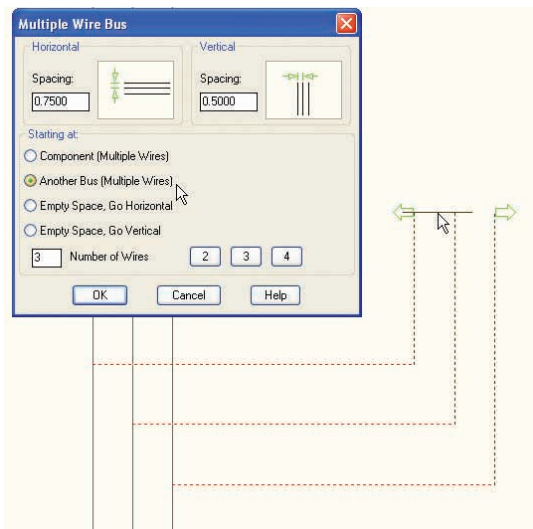

New Drawing Command

With a single click of a button, you can begin a new drawing and know that AutoCAD Electrical is fully aware of the current project settings. After you choose a template with the appropriate title block and drawing border, the new drawing automatically becomes part of the active project and you are ready to start inserting devices.

Swap Block Utility

Save hours of rework by quickly replacing each instance of a symbol throughout a project. Swap instances of a block or an individual symbol wherever it is used in a project. You can even swap symbols for an entire project between two symbol libraries. For example, if you need to change the standard used in a project, just run this command to automatically swap each JIC device out with its IEC equivalent.

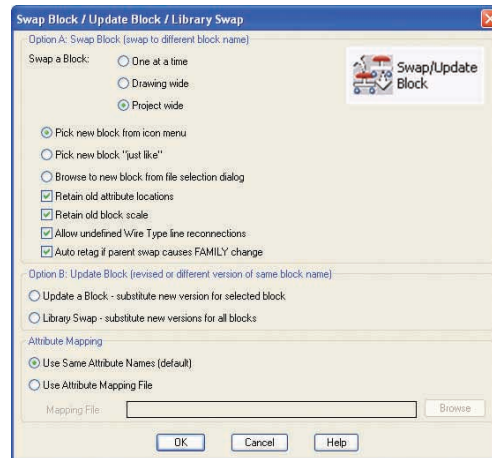

Retagging Components

Reduce design time and help eliminate errors by retagging all components in a project with a single command. This single command enables users to change the format of component tags during a project to accommodate customer changes on the fly.

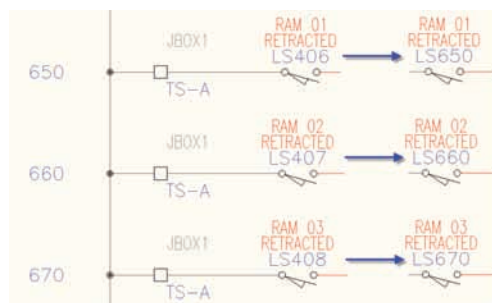

Design and Drafting Productivity Tools

Fixed Wire Numbers and Component Tags

AutoCAD Electrical enables you to easily accommodate design modifications late in the cycle without affecting previous work. When you change the status of wire numbers and component tags to a “fixed” format, they remain unaffected during a project-wide renumbering of wires or retagging of components. If changes are required after the shop floor has the designs, you can easily add new wire numbers and device components without affecting the existing wire numbers.

Wire Label Export for Electrical Design

Slash the time it takes to create an accurate set of wire labels for a project. With the Wire Label Export command, you can rapidly extract wire numbers from an entire project and print the required labels for each wire.

Toggle Normally Open/Normally Closed

With a single mouse-click, switch the state of a device from normally open to normally closed and vice versa. If that device is part of a parent/child relationship, such as a relay coil and contact, AutoCAD Electrical automatically updates the corresponding device.

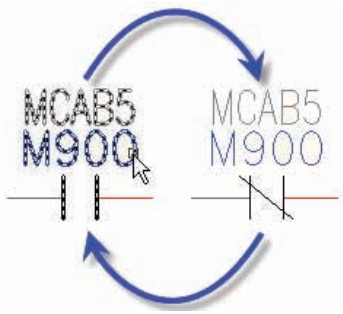

Drawing Navigation Features for Control Designers

Quickly navigate through drawings within a project. Use the previous/next buttons to each drawing in the project without having to open individual files.

Device Navigation

Don't waste any more of your valuable time managing device relationships. With AutoCAD Electrical you can easily view and navigate relationships between devices using the Surfer command. Simply click a component in the panel layout drawing and quickly “surf” to the corresponding schematic device. This command works across multiple drawings in a project and also works on devices with a parent/child relationship, auxiliary contacts, and item numbers.

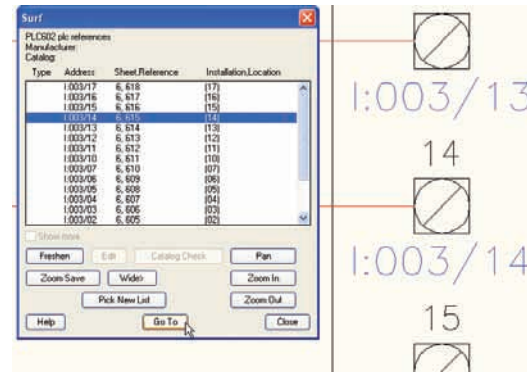

Open and Flexible API

Create simplified custom front-end interfaces or automated workflows using an open architecture that integrates with existing business and engineering systems. Use the flexible and open API (application programming interface) in AutoCAD Electrical to extend its power and functionality to meet specific design and drafting needs. This built-in API consists of nearly 200 programming entry points into the software, so users can easily integrate AutoCAD Electrical with their existing business and engineering systems.

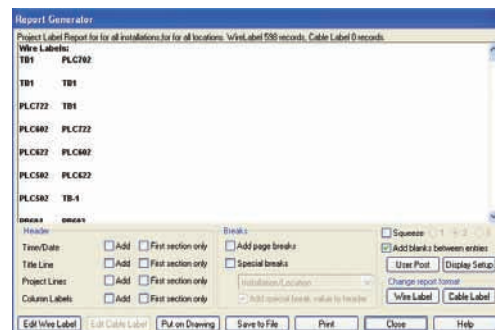

Schematic Design Tools

Create and modify electrical control schematics more accurately and in fraction of the time it takes with AutoCAD®.

Electrical-Specific Drafting Commands

Save hours of design time using specialized drafting features in AutoCAD Electrical developed specifically for designing control systems. Quickly trim wires, copy and delete components or circuits, and scoot and align components for easier drawing creation.

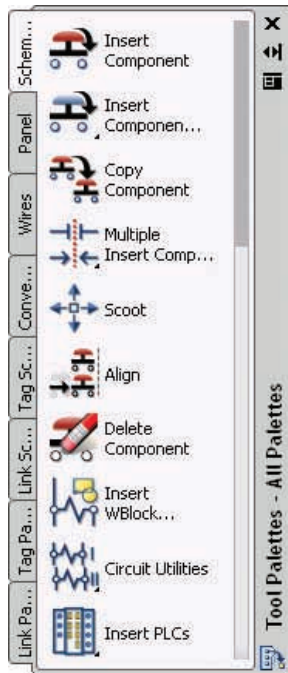

Ladders and Reference Line Numbers

Use the flexible ladder insertion functionality in AutoCAD Electrical to quickly place ladders into a drawing, minimizing the redundancy of creating control drawings. Place ladders horizontally or vertically while maintaining complete control over all ladder characteristics, including rung spacing, number of rungs, and ladder width. Reduce tedious manual processes with automatic placement of reference line numbers based on a predefined configuration.

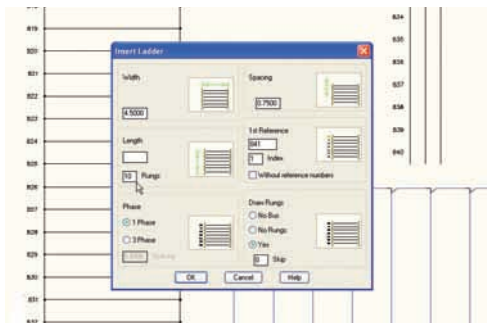

Automatic Wire Gaps

Effortlessly create easy-to-read schematics. Whenever two wires cross in an electrical design, AutoCAD Electrical automatically indicates which wire passes through. You can choose from wire gaps, loops, or solid wires to show crossing wires.

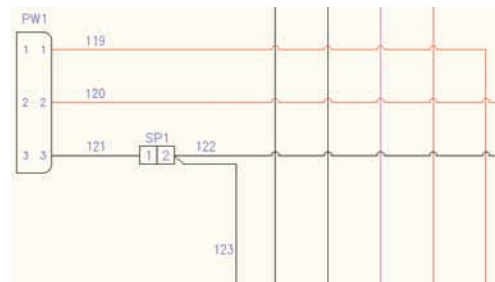

Visual Wiring Sequence Indicators

Efficiently communicate design intent to manufacturing and avoid wiring errors by graphically indicating the proper wiring sequence of a circuit directly on the schematic. When you make changes to a wire sequence, the updated information is automatically accurately reflected in the from/to wire list report.

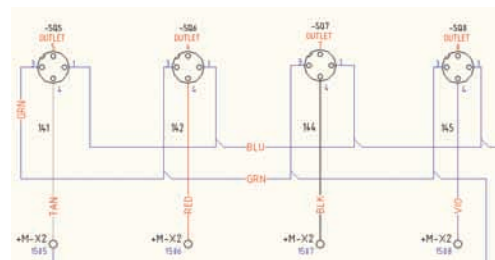

Revise Ladder

With AutoCAD Electrical you don't have to start from scratch when you need to modify a ladder in your design. Use the Revise Ladder command to modify ladders already inserted into drawings. Without deleting and starting over again, you can modify most aspects of the ladder, including rung spacing and number of rungs, as well as starting and ending reference numbers. This single command saves hours of manual editing and helps ensure that your time is spent on high-value work.

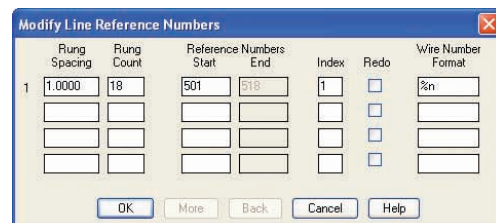

Schematic Design Tools

Insert Rungs

Being able to quickly insert rungs into an existing ladder greatly speeds up the drafting of electrical control schematics. Simply click anywhere inside a ladder to insert a new rung complete with wire connection dots and automatically align it with the corresponding wire numbers.

Three-Phase Motor Control

Save time and increase productivity when creating three-phase motor circuits. Quickly design motor circuits using intelligent, built-in symbol libraries that include three-pole breakers, switches, motor contactors, and more. When you insert them, these symbols adapt to the underlying three-phase rung spacing automatically.

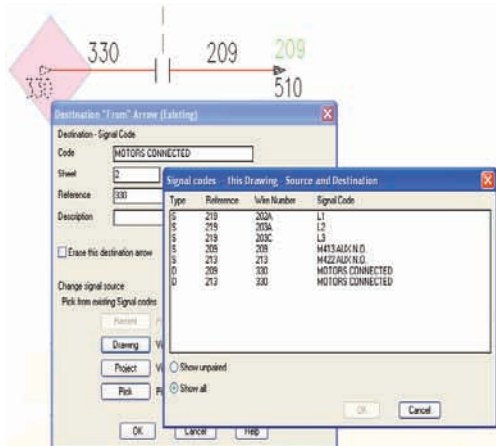

Connector Generator

Quickly generate connectors by providing minimal information, such as the number of pins and orientation. The resulting connector is ready to be wired into a design. With AutoCAD Electrical, you'll be able to generate accurate point-to-point style designs in a fraction of the time it takes with traditional AutoCAD software.

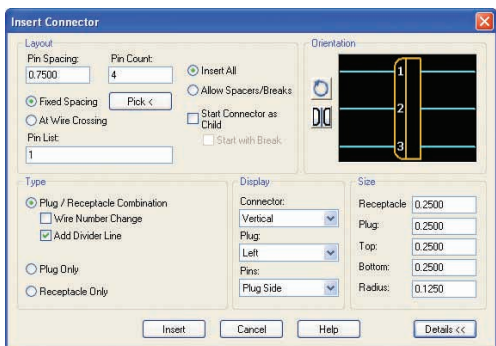

Source and Destination Markers

Quickly track wires from page to page within a project. When a wire starts on one drawing and continues onto another, you can connect them electronically using the source and destination signals.

Cable and Conductor Tracking

Easily manage cable and conductor usage in AutoCAD Electrical projects with automatic tracking capabilities. Designate individual wires as belonging to a cable, and then generate reports based on cable usage for fabrication purposes. Similar to inserting components, when you assign manufacturer part number information to cables, AutoCAD Electrical automatically tracks and reports conductor usage based on that part number.

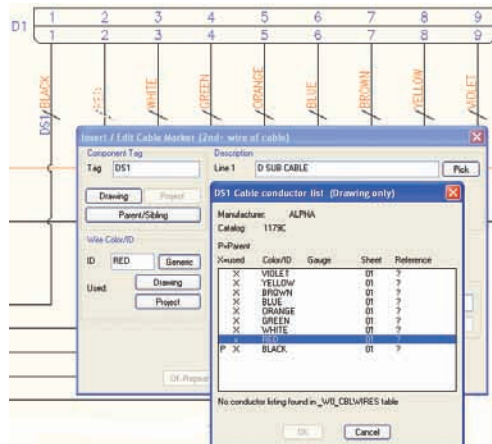

Project Interface

Easily manage and navigate the many individual DWG™ files that make up an electrical control systems project with the AutoCAD Electrical project interface. The intuitive file management features in AutoCAD Electrical let you spend more time designing and less time organizing files.

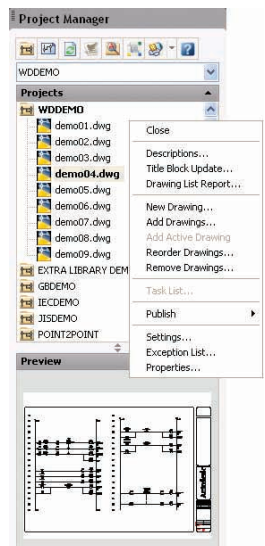

Panel Layout Tools

Quickly and easily create panel layout drawings with intelligent updating to reduce errors.

Create Smart Panel Layout Drawings from Electrical Schematics

Using AutoCAD® Electrical to create panel layout drawings gives you a systematic means of checking that no devices are missed and makes an electronic link between the representation of the device in the schematic and panel drawings.

Here's how it works: Once you have created an electrical schematic, the software extracts a list of schematic components for placement in the panel layout drawings. You simply choose a device from the list and drag it into place. The physical "footprint" representation of each schematic device is inserted into the layout at the point you select. Then the software creates an electronic link between the schematic and panel device representations. So when you change key data on one drawing, you get a prompt for permission to update the other. Even non-schematic items like wire duct and mounting hardware can be added to the layout and automatically combined to create a "smart" panel bill of materials (BOM) report.

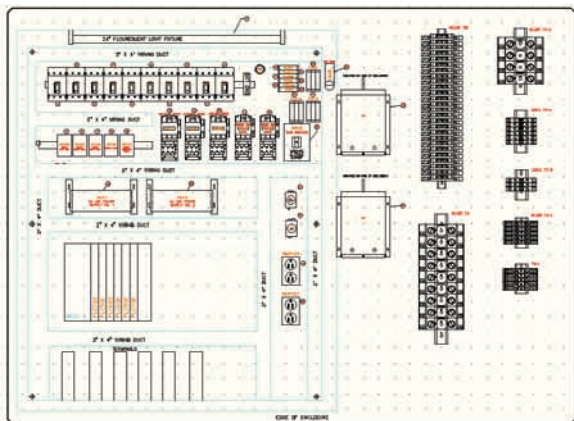

Starting Designs with a Panel Layout Drawing

AutoCAD Electrical provides a flexible design environment that works the way you want to work. You can start designs by creating a panel layout drawing and using it to drive the creation of the corresponding logical control schematics. This feature gives you the boost you need for tight turnaround times and supports the needs of individual designers.

Location Boxes and Markers

Quickly and easily associate groups of devices with a specific panel location using the Location Box command. Apply location markers on the schematic that represent the corresponding panel location. This capability makes it easy to identify locations for a device or group of devices, resulting in more accurate panel layouts.

Insert Balloons on Panel Devices

Save time by automatically annotating control panel drawings with intelligent item balloons that coincide with the panel BOM.

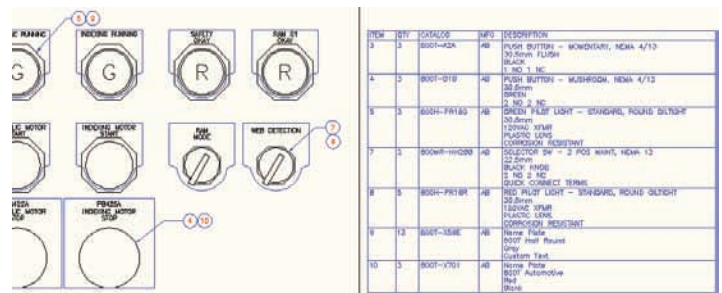

Programmable Logic Controller (PLC) Tools

AutoCAD Electrical includes a set of tools specifically designed to increase your productivity and accuracy when working with PLC I/O drawings.

PLC I/O Libraries

Quickly create PLC I/O drawings by selecting from a library of more than 3,000 intelligent PLC I/O modules from the industry's most popular vendors.

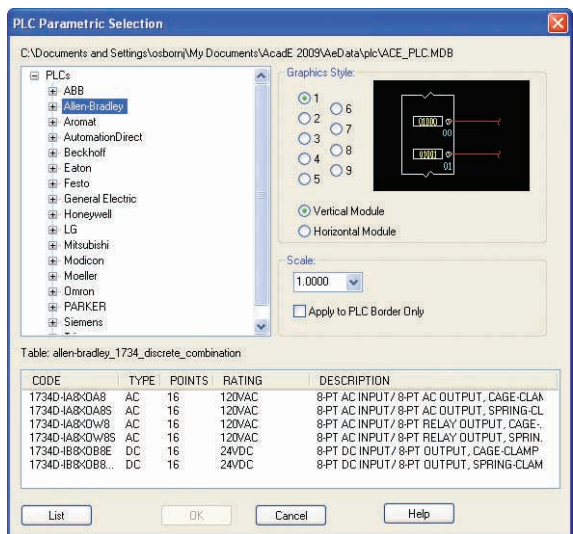

PLC I/O Import/Export

Export critical I/O address and description information into multiple file formats. Exchange data bi-directionally between AutoCAD Electrical and Rockwell Automation's PLC programming software or Schneider Electric's Unity™ software products. Reusing crucial design data between AutoCAD Electrical and the corresponding PLC program helps you reduce design time and minimize errors.

Automatically Create PLC I/O Drawings from Spreadsheets

Generate a complete set of PLC I/O drawings simply by defining the project's I/O assignments in a spreadsheet program. This capability can save you a tremendous amount of design time by virtually eliminating the need to create those drawings in an AutoCAD® environment.

Once the drawings have been created, easily export the I/O information and descriptions to a format that most PLC programming software packages can read. The PLC programmer won't need to recreate addresses and their descriptions. Then import the descriptions on each PLC I/O point into your PLC program to maintain consistency between your drawings and your PLC program.

PLC Module Builder

The PLC module builder makes it easy to add PLC I/O modules to the standard library. If desired modules are not included in the currently library, you can simply add them through a graphical interface.

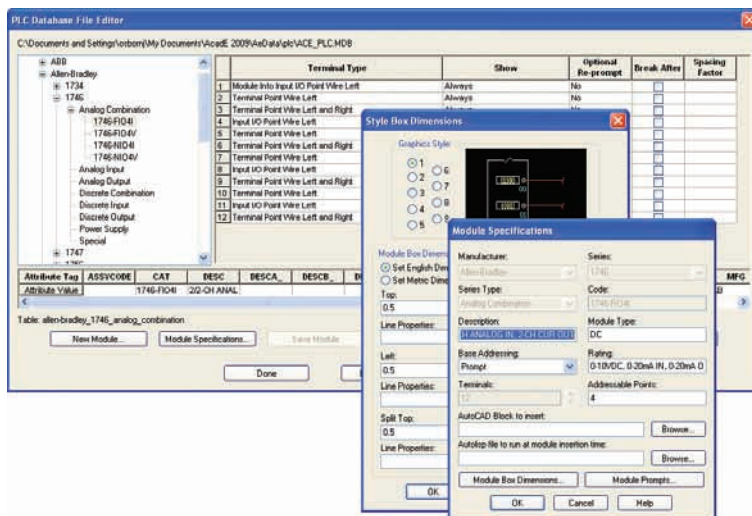

Comprehensive Terminal Management

Increase design accuracy and reduce the complexity of working with terminals in a design.

Graphical Terminal Strip Generator

Slash design time by automatically generating graphical terminal strip layouts based on schematic design information for use in panel layout drawings or terminal plans. You can choose to generate these terminal strips in a graphical or table format. AutoCAD Electrical automatically populates terminal strip layouts with the wiring information for each side of the strip as defined in the Terminal Strip Editor.

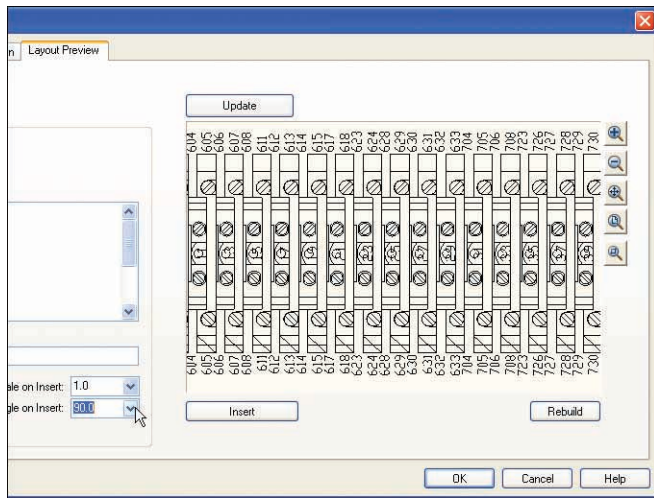

Terminal Strip Editor

Easily manage and edit terminals throughout a project with the simplified Terminal Strip Editor interface. With only a few clicks, you can insert spare terminals or make modifications, such as reversing the left and right wiring information for a terminal.

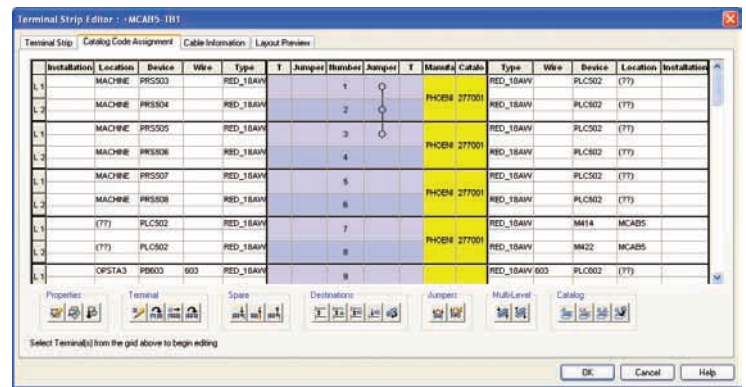

Terminal Jumpers

Easily view, create, and edit jumpers within the Terminal Strip Editor. Reduce design time and help eliminate errors by accurately representing terminal jumpers as part of the control design.

Inserting Spare Terminals

Provide accurate bill of material (BOM) information by eliminating the guesswork encountered when planning for spare terminal needs. Users can insert spare terminals through the Terminal Strip Editor and accurately update various terminal reports.

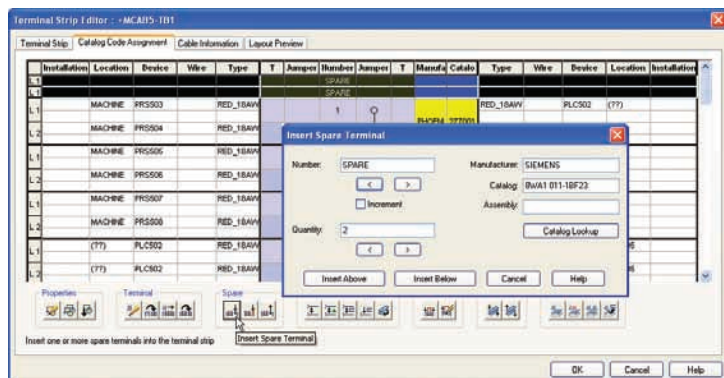

Multitier Terminals

Reduce the complexity of using multilevel terminals in a control design. AutoCAD Electrical enables you to define and manage the terminal numbers as well as all connectivity information, within a single, easy-to-use dialog.

Direct to Terminal Wire Sequencing

Deliver more accurate reports by taking advantage of the flexibility in the level of control available when defining the wire connection sequence. Land wires from multiple devices onto a common terminal, and have all information accurately reflected in various terminal and wiring reports.

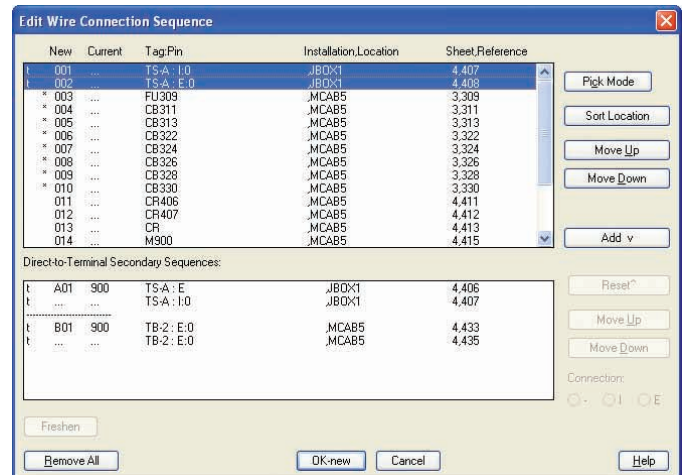

Collaboration and Interoperability

The sharing of accurate design data between AutoCAD Electrical and other Autodesk® applications enables electrical and mechanical teams to smoothly collaborate on digital prototypes.

Link to the Cable and Harness Functionality of Autodesk® Inventor® Professional

Quickly create accurate 2D and 3D electrical control designs using the bi-directional interoperability between AutoCAD® Electrical and Autodesk® Inventor® Professional software. Pass electrical intent information for cables and conductors from AutoCAD Electrical to Autodesk Inventor Professional to automatically create a 3D harness design. And, pass wire-connectivity information from Autodesk Inventor Professional to AutoCAD Electrical to automatically create the corresponding 2D schematics.

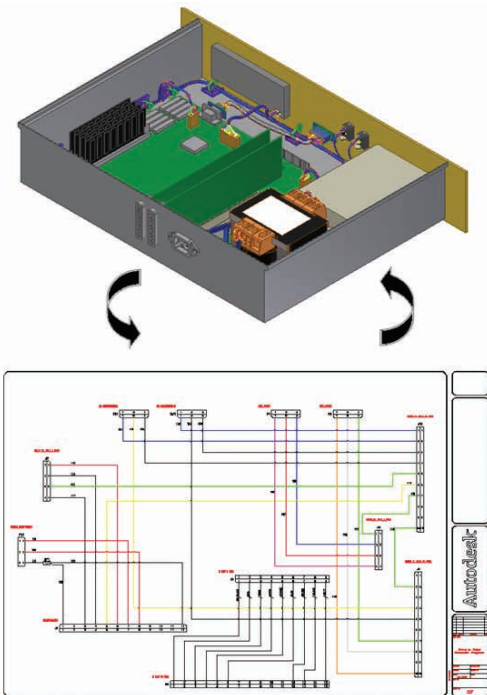

Share Drawings and Track Changes

Easily exchange data with customers or suppliers in native DWG™ format. AutoCAD Electrical drawings can be viewed and edited by any DWG-compatible program such as AutoCAD or AutoCAD® LT software. With the built-in AutoCAD Electrical revision tracking functionality, you can track all changes made to your drawings since the last update, no matter how many people accessed them.

Multuser Environment

Collaborate more effectively and increase productivity while sharing projects within workgroups. AutoCAD Electrical control design software provides drawing status indicators and better control of project-wide commands to improve efficiency in multi-user environments.

Publish Designs on the Web

AutoCAD Electrical makes it easy to share designs with your extended enterprise by publishing either individual drawings or entire projects on the web. AutoCAD Electrical creates the HTML pages as well as the links you need to post your complete design to the web.

DWF Tools

Publish DWF™ files directly from Autodesk manufacturing design applications, and securely collaborate on 2D and 3D designs with customers, suppliers, planners, and others outside your engineering workgroup. Using free* Autodesk® Design Review software, team members can digitally review, measure, mark-up, and comment on your 2D and 3D designs while protecting your intellectual property. Tight integration with Autodesk manufacturing products enables accurate communication of design information, including assembly instructions, bills of material (BOMs), and finite element analysis (FEA) results without requiring CAD expertise. Autodesk Design Review software automatically tracks comments and their status, and the DWF-based markups can be round-tripped, helping speed the revision process and minimize information loss.

*Free products are subject to the terms and conditions of the end-user license agreement that accompanies download of the software.

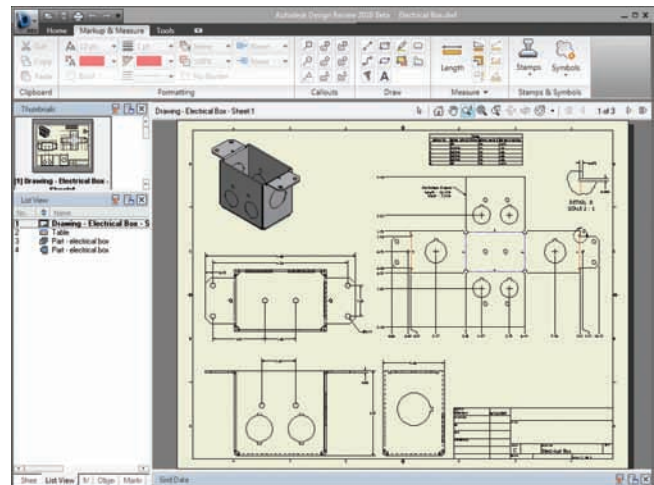

Data Management and Reporting Tools

Fully integrated data management tools make it easy to securely store and manage your work-in-process electrical design data. AutoCAD® Electrical also includes built-in tools that instantly generate and update critical reports so you can provide accurate information to manufacturing and save hours on document maintenance.

Integrated Data Management

Accelerate development cycles and increase your ROI by reusing existing designs. AutoCAD Electrical includes integrated data management tools for workgroups that securely store and manage work-in-progress electrical design data and related documents.

Autodesk® Vault Manufacturing

Autodesk® Vault Manufacturing software (sold separately and previously known as Autodesk® Productstream®) securely stores and manages engineering information, design data, and documents, enabling you to shorten the design-to-manufacturing process. It helps design, engineering, and manufacturing departments across separate locations collaborate and share Digital Prototyping information. It also gives your design departments advanced tools to track engineering change orders, manage BOMs, and promote earlier collaboration through integration with manufacturing business systems. With support for multi-CAD environments, Vault allows you to share and manage designs and engineering data created with third-party software and AutoCAD® software throughout the product lifecycle.

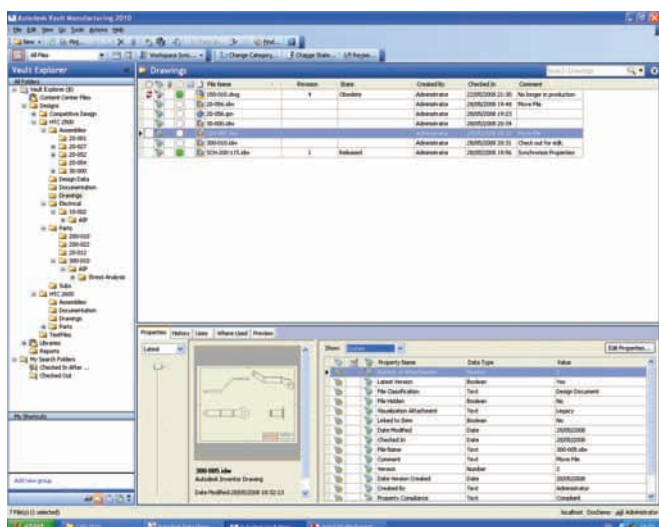

Automatic Report Generation

Drastically reduce the time required to create and update reports, while removing associated errors of producing reports manually. Report generation in AutoCAD Electrical is simple, customizable, and gives you the option of running multiple reports with a single command.

You can automatically generate reports that cover bills of material (BOM), from/to wire lists, PLC I/O, terminal plans, cable summaries, and cross-referencing reports.

Customize reports to display relevant information by sorting and filtering available fields, which can be run on a current drawing, collection of drawings, the entire project, or a specific location or panel. Place reports into a drawing as a smart table object that can be easily updated later or saved to a file. AutoCAD Electrical supports saving reports in ASCII, Microsoft® Excel®, Microsoft® Access®, CSV, or XML formats.

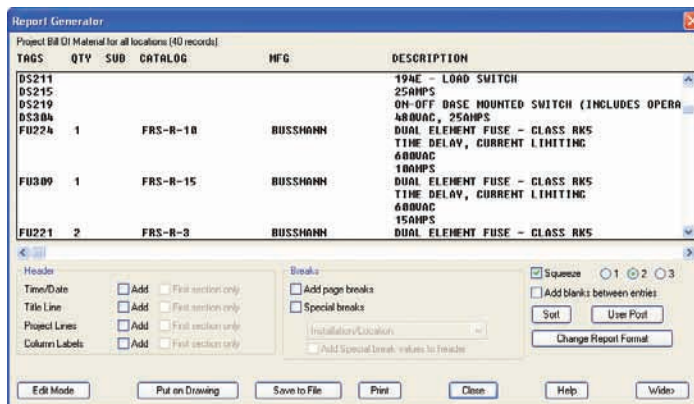

Surfable Reports

Navigate reports and their corresponding designs with the surfable reports feature. When you place reports into a design as a table, you can click the various fields to instantly find the corresponding devices in the schematics or panel layout drawings.

Drawing List Report

AutoCAD Electrical can extract a list of project drawings that lists drawing numbers, titles, dates, revisions, and other important data. Create a list of data extracted from the project drawing title blocks and save to file, print, or insert it into a drawing.

Data Migration Tools

Save hours of rework by leveraging your existing design data from AutoCAD® and other products. Automatically convert data into intelligent AutoCAD® Electrical designs without losing previous customizations.

Migration Utility

The migration utility lets you easily migrate from your previous version of AutoCAD Electrical design software to the latest release while preserving your existing data and settings.

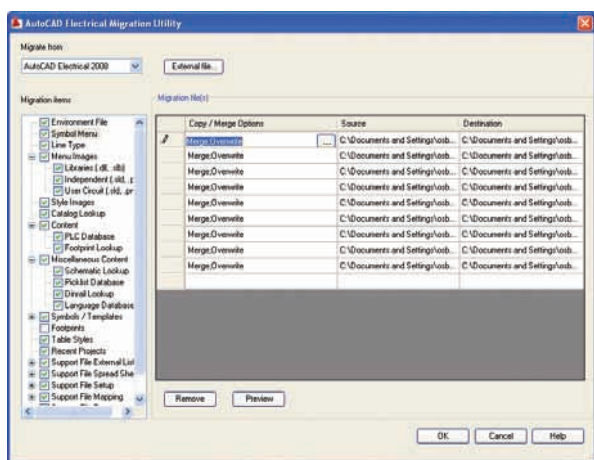

AutoCAD Data Migration

Quickly bring existing designs created in AutoCAD® or AutoCAD LT® software into AutoCAD Electrical for further modification with the data migration utilities. The migration tools in AutoCAD Electrical, drastically speed up the conversion of native AutoCAD data into intelligent AutoCAD Electrical designs. You'll be able to realize the advantages of using purpose-built electrical design tools faster.

promis•e Data Migration

Users of promis•e® software can avoid hours of rework by easily migrating designs into AutoCAD Electrical design software using the promis•e data migration tools.

Content Database Merge Utility

Use this powerful utility to easily merge existing manufacturer catalog databases, PLC I/O libraries, footprint lookup databases, and corresponding footprint symbols with content delivered in each new release. You'll be able take full advantage of content additions in new releases, without losing previous customizations you made to current content libraries.

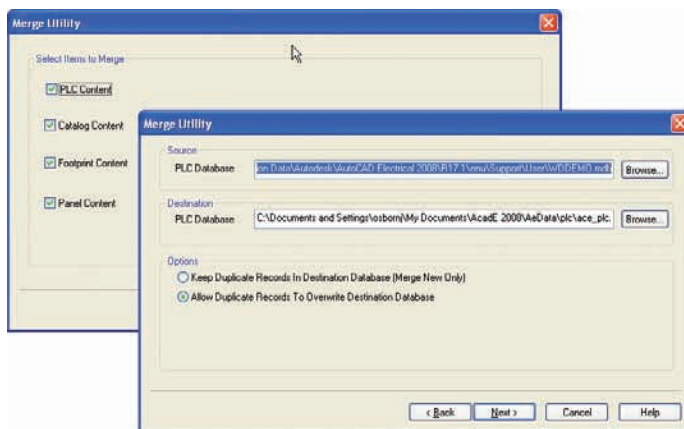

Digital Prototyping for the Manufacturing Market

Autodesk, a world-leading supplier of engineering software, provides tools that let viewers experience ideas before they are real. By putting powerful Digital Prototyping technology within the reach of mainstream manufacturers, Autodesk is changing the way manufacturers think about the design process and helping create more productive workflows. The Autodesk approach to Digital Prototyping is scalable, attainable, and cost-effective; allows a broader group of manufacturers to realize its benefits with minimal disruption to existing workflows; and provides the most straightforward path to creating and maintaining a single digital model in a multidisciplinary engineering environment.

Learn More or Purchase

Access specialists worldwide who can provide product expertise, a deep understanding of your industry, and value that extends beyond your software purchase. To purchase AutoCAD Electrical software, contact an Autodesk Premier Solutions Provider or Autodesk Authorized Reseller. Locate a reseller near you at www.autodesk.com/reseller.

Autodesk Learning and Education

From instructor-led or self-paced classes to online training or education resources, Autodesk offers learning solutions to fit your needs. Get expert guidance at an Autodesk Authorized Training Center (ATC[®]) site, access learning tools online or at your local bookstore, and validate your experience with Autodesk certifications. Learn more at www.autodesk.com/learning.

Autodesk Services and Support

Accelerate return on investment and optimize productivity with innovative purchase methods, companion products, consulting services, and support from Autodesk and Autodesk authorized partners. Designed to get you up to speed and keep you ahead of the competition, these tools help you make the most of your software purchase—no matter what industry you are in. Learn more at www.autodesk.com/servicesandsupport.

Autodesk Subscription

Get the benefits of increased productivity, predictable budgeting, and simplified license management with Autodesk[®] Subscription. You get any new upgrades of your Autodesk software and any incremental product enhancements, if these are released during your Subscription term. In addition, you get exclusive license terms available only to Subscription members. A range of community resources, including web support direct from Autodesk technical experts, self-paced training, and e-Learning, help extend your skills and make Autodesk Subscription the best way to optimize your investment. Learn more at www.autodesk.com/subscription.

*Free products are subject to the terms and conditions of the end-user license agreement that accompanies download of this software.

Autodesk, AutoCAD, AutoCAD LT, Autodesk Inventor, AutoLISP, DWF, DWG, DWG (logo), Inventor, Productstream, and Visual LISP are registered trademarks or trademarks of Autodesk, Inc., and/or its subsidiaries and/or affiliates in the USA and/or other countries. All other brand names, product names, or trademarks belong to their respective holders. Autodesk reserves the right to alter product offerings and specifications at any time without notice, and is not responsible for typographical or graphical errors that may appear in this document.

© 2009 Autodesk, Inc. All rights reserved. 225A1-000000-MZ07